

## HONDA



ST50 - 70 CT70 - CT70H  
1969 - 1982 Shop Manual

# INDEX

Click on the section you want to go to

## Specifications - 7

## Special Tools - 12

## Engine - 14

Engine Removal & Installation - 14

Lubrication System - 16

Cylinder & Cylinder Head - 17

Cam Chain Tensioner - 23

Piston & Piston Rings - 23

Clutch - 25

Crankshaft - 27

Transmission - 29

Gear shift Mechanism - 31

Kick Starter - 32

Carburetor - 33

Tightening Torque Limits - 35

## Frame - 36

Handlebar - 36

Front Fork - 37

Front Cushion - 38

Rear Cushion - 40

Front Wheel - 41

Rear Wheel - 44

Braking System - 46

Rear Fork - 47

Drive Chain - 48

Air Cleaner - 48

## Electrical System - 49

A.C Generator Inspection - 50

Ignition Coil - 50

Condenser Inspection - 51

Silicon Rectifier - 52

Battery - 52

Switches - 53

## Wiring Diagrams

ST50 (U.K Type) - 57

ST70 - I (General Export) - 58

ST70 - II (General Export) - 59

CT70 (U.S.A Type) - 60

CT70H (U.S.A Type) - 61

## Index - 62

CT70 K4 Addendum - 63

CT70 K6 1977 Addendum - 67

CT70 K7 1978 Addendum - 71

CT70 Z 1979 Addendum - 73

CT70 A 1980 Addendum - 97

CT70 B 1981 Addendum - 115

CT70 C 1982 Addendum - 117

Maintenance Schedule - 119

**Official**

# **HONDA**

## **SHOP MANUAL**

### **ST50-70**

### **CT70-70H**

# **1969-1982**

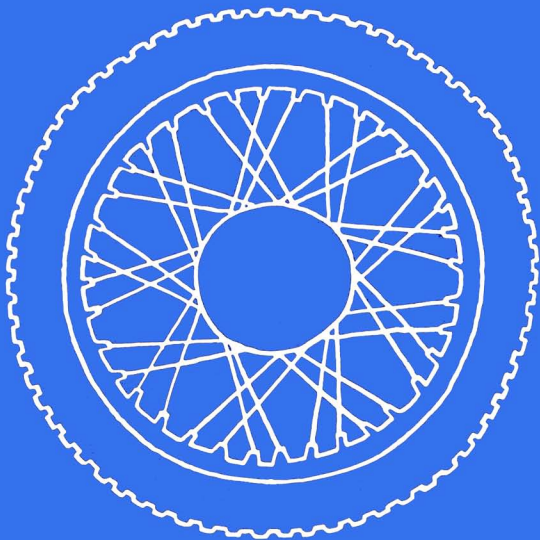

— IMPORTANT SAFETY NOTICE —

**WARNING** *Indicates a possibility of personal injury or loss of life if instructions are not followed.*

**CAUTION** *Indicates a possibility of equipment damage if instructions are not followed.*

Detailed descriptions of standard workshop procedures, safety principles and service operations are not included. It is important to note that this manual contains some warnings and cautions against some specific service methods which could cause PERSONAL INJURY to service personnel or could damage a vehicle or render it unsafe. Please understand that those warnings could not cover all conceivable ways in which service, whether or not recommended by Honda might be done or of the possible hazardous consequences of each conceivable way, nor could Honda investigate all such ways. Anyone using service procedures or tools, whether or not recommended by Honda *must satisfy himself thoroughly* that neither personal safety nor vehicle safety will be jeopardized by the service methods or tools selected.

## FOREWORD

This manual covers information on models ST 50, ST 70, CT 70, CT 70 K1, CT 70 K2, CT 70 K3, CT70H, and CT 70H KI. This manual should be kept in a place for easy reference with **50/65 Shop Manual (Code No. 620401)**. If properly used it will enable the service shops to provide reliable service to the owners.

All information, illustrations and specifications contained in this publication, are based on the latest product information available at the time of publication. Honda Motor Co., Ltd. reserves the right to make changes at any time without notice.

Following are the initial serial numbers of each model at the time of change:

ST 50 E (England type)	ST 50— 111528~
ST 70 D I (General type)	ST 70— 108801~
ST 70 D II (General type)	ST 70— 505971~
ST 70 E (England type)	ST 70— 137314~
CT 70 H (U. S. A. type)	CT 70H—100001~
CT 70 H KI (U. S. A. type)	CT 70H KI—2000001~
CT 70 (U. S. A. type)	CT 70— 100001~
CT 70 K1 (U. S. A. type)	CT 70—2000001~
CT 70 K2 (U. S. A. type)	CT 70—2100001~
CT 70 K3 (U. S. A. type)	CT 70—2300001~

# CONTENTS

	Reference Page →	
	Shop Manual ST50/70, CT70H, HKI CT70, K1, K2, K3/70H	Shop Manual 50/65
<b>1. Specifications</b>		
1.1 Specifications .....	5	
<b>2. Special Tools</b> .....	10	
<b>3. Engine</b>		
3.1 Engine Removal and Installation .....	12	
3.2 Lubrication System .....	14	..... 11
3.3 Cylinder and Cylinder Head .....	15	..... 12~24
3.4 Cam Chain Tensioner .....	21	..... 24
3.5 Piston and Piston Rings .....	21	..... 19~23
3.6 Clutch .....	23	..... 26~28
3.7 Crankshaft .....	25	..... 29~31
3.8 Transmission .....	27	..... 31~33
3.9 Gear Shift Mechanism .....	29	
3.10 Kick starter .....	30	..... 33~34
3.11 Carburetor .....	31	..... 35~45
3.12 Tightening Torque Limits .....	33	
<b>4. Frame</b>		
4.1 Handlebar .....	34	
a. Handlebar Construction .....	34	
b. Disassembly .....	34	
c. Inspection .....	35	
d. Reassembly .....	35	
4.2 Front Fork .....	35	
a. Disassembly .....	35	
b. Inspection .....	35	
c. Reassembly .....	36	
4.3 Front Cushion .....	36	
a. Front Cushion Construction .....	36	
b. Disassembly .....	36	
c. Inspection .....	38	
d. Reassembly .....	38	
4.4 Rear Cushion .....	38	
a. Rear Cushion Construction .....	38	
b. Disassembly .....	39	
c. Inspection .....	39	
d. Reassembly .....	39	

	Shop Manual ST50/70, CT70, K1, K2, K3/70H	Shop Manual 50/60
4. 5 Front Wheel .....	39	
a. Front Wheel Construction .....	40	
b. Disassembly .....	40	
c. Inspection .....	40	
d. Reassembly .....	41	
4. 6 Rear Wheel .....	42	
a. Rear Wheel Construction .....	42	
b. Disassembly .....	42	
c. Inspection .....	43	
d. Reassembly .....	43	
4. 7 Braking System .....	44	
a. Disassembly .....	44	
b. Inspection .....	45	
c. Reassembly .....	45	
4. 8 Rear Fork .....	45	
a. Disassembly .....	45	
b. Inspection .....	45	
c. Reassembly .....	46	
4. 9 Drive Chain .....	46	
4.10 Air Cleaner .....	46	
<b>5. Electrical System</b>		
5. 1 A.C. Generator Inspection .....	47	
5. 2 Ignition coil .....	48	
5. 3 Condenser Inspection .....	49	
5. 4 Silicon Rectifier .....	50	
5. 5 Battery .....	50	
5. 6 Switches .....	51	
<b>6. Wiring Diagram</b> .....	55	
<b>7. Index</b> .....	60	
<b>8. Periodic Adjustment</b> .....	83~99	
<b>9. Trouble Shooting</b> .....	101~109	
<b>10. CT70 K4 ADDENDUM</b> .....	61	
<b>11. CT70 K6 '77 ADDENDUM</b> .....	65	
<b>12. CT70 K7 '78 ADDENDUM</b> .....	69	
<b>13. CT70 Z '79 ADDENDUM</b> .....	71	
<b>14. CT70 A '80 ADDENDUM</b> .....	95	
<b>15. CT70 B '81 ADDENDUM</b> .....	113	
<b>16. CT70 C '82 ADDENDUM</b> .....	115	

# I. SPECIFICATIONS

## I.1 Specifications

ITEMS	ST 50 (England type)	ST 70 (General type)	CT 70 (U.S.A. Type)	CT 70H (U.S.A. Type)
<b>DIMENSION</b>				
Overall Length	1,510 mm (59.8 in.)	←	←	←
Overall Width	580 mm (22.8 in.)	←	←	←
Overall Height	960 mm (37.8 in.)	←	←	←
Wheel Base	1,035 mm (40.7 in.)	←	←	←
Ground Clearance	165 mm ( 6.5 in.)	←	180 mm (7.1 in.)	←
Curb Weight	64 kg (141.1 lb.)	65 kg (143.3 lb.)	62 kg (136.7 lb.)	65 kg (143.3 lb)
<b>FRANE</b>				
Type	T-bone type	←	←	←
Suspension, F.	Telescopic fork	←	←	←
Suspension, R.	Swing arm	←	←	←
Tire Size, F.	3.50-10 (2 PR)	←	4.00-10 (2 PR)	←
Tire Size, R.	3.50-10 (2 PR)	←	4.00-10 (2 PR)	←
Brake	Internal expanding shoe	←	←	←
Fuel Capacity	2.5 lit (5.28 U.S. pt. 4.46 Imp. pt.)	←	←	←
Tire Pressure, F.	1.0 kg/cm <sup>2</sup> (14.2 psi)	←	1.1 kg/cm <sup>2</sup> ~1.3 kg/cm <sup>2</sup> (15.6 psi~18.5 psi)	←
Tire Pressure, R.	1.2 kg/cm <sup>2</sup> (17.0 psi)	←	1.3 kg/cm <sup>2</sup> ~1.5 kg/cm <sup>2</sup> (18.5 psi~21.3 psi)	←
Caster Angle	65°	←	←	←
Trail Length	0.058 m (2.3 in.)	←	←	←
<b>ENGINE</b>				
Type	Air, cooled, 4-stroke O.H.C	←	←	←
Cylinder Arrangement	Single 80° inclined from vertical	←	←	←
Bore and Stroke	47×41.4 mm (1.85×1.63 in.)	←	←	←
Displacement	72 cc (4.4 cu-in.)	←	←	←
Compression Ratio	8.8	←	←	←

CT 70K1 (U.S.A. Type)	CT 70K2 (U.S.A. Type)	CT 70K3 (U.S.A. Type)
1, 515 mm (59. 6 in)	←	←
660 mm (26. 0 in)	←	←
1, 010 mm (39. 8 in)	←	←
1, 050 mm (41. 3 in)	←	←
190 mm ( 7. 5 in)	←	←
73 kg (161 lb)	←	←
Steel pressing	←	←
Telescopic fork	←	←
Swing arm	←	←
4. 00-10 (2 PR), Kobby tire	←	←
4. 00-10 (2 PR), Kobby tire	←	←
Internal expanding shoe	←	←
2. 5lit (5. 28U. S. Pt. 4. 46 Imp pt.)	←	←
1. 2 kg/cm <sup>2</sup> (17 psi)	←	←
1. 4 kg/cm <sup>2</sup> (20 psi)	←	←
63°	←	←
0. 070m (2. 7 in)	0. 071m (2. 8 in)	←
Air cooled, 4-stroke O. H. C	←	←
Single 80° inclined from vertical	←	←
47×41. 4mm (1. 85×1. 63 in)	←	←
72cc (4. 4 cu-in)	←	←
8. 8	←	←



ITEMS	ST 50 (England type)	ST 70 (General type)	CT 70 (U.S.A. Type)	CT 70H (U.S.A. Type)
Carburetor	KEIHIN, piston valve type	←	←	←
Valve Train	Chain driven over head camshaft	←	←	←
Oil Capacity	0.8 lit (1.7 U.S. pt. 1.4 Imp.pt.)	←	←	0.7 lit (0.74 U.S. pt. 1.62 Imp. pt.)
Lubrication System	Forced and wet sump	←	←	←
Engine Weight (includes oil)	18.5 kg (40.8 lb)	←	←	18 kg (39.7 lb)
<b>DRIVE TRAIN</b>				
Clutch	Wet, multi-plate, automatic centrifugal type	←	←	Wet, multi-plate, manual type
Transmission	Constant mesh, 3-speed	←	←	4-speed
Primary Reduction	3.722	←	←	←
Gear Ratio I	3.364	←	←	2.692
Gear Ratio II	1.722	←	←	1.824
Gear Ratio III	1.190	←	←	1.300
Gear Ratio IV		←	←	2.958
Final Reduction	2.733	2.533	←	←
Gear Shift Pattern	1-N-2-3	Left foot operated return system 1-N-2-3      N-1-2-3		N-1-2-3-4
<b>PERFORMANCE</b>				
Max. Speed	70 km/H (43.0 mile/H)	75 km/H (47.0 mile/H)	←	75 km/H (47.0 mile/H)
Maximum Horsepower HP/rpm	4.5/9000	5.6/8000	5.0/8000	4.0/8000
Maximum Torque kg-m/rpm	0.87/8000	0.511/7000	0.50/5500	0.50/4000
Climbing Ability Sin $\theta$	0.276	←	0.309	←
Turning Circle	3.2 m (10.50 ft.)	←	←	←

CT 70HK1 (U.S.A. Type)	CT 70K1 (U.S.A. Type)	CT 70K2 (U.S.A. Type)	CT 70K3 (U.S.A. Type)
KEIHIN, piston	←	←	←
Valve type			
Chain driven over-head camshaft	←	←	←
0.7 lit (0.7 U.S. qt. 0.6 Imp.qt)	←	←	←
Forced and wet sump	←	←	←
18.0 kg (40 lb)	←	←	←
Wet, multi-plate, manual type	←	←	←
4-Speed	←	←	←
3.722	4.058	←	←
2.692	3.272	←	←
1.823	1.824	←	←
1.300	←	←	←
3.214	2.333	←	←
N-12-3-4	←	←	←
75 km/H (47.0 mile/H)	←	←	←
4.5/8500	4.0/8000	←	←
3.61/4000	←	3.64/3500	←
18°	←	←	←
3.2m (10.50 ft.)		←	←

ITEMS	ST 50 (England type)	ST 70 (General type)	CT 70 (U.S.A. Type)	CT 70H (U.S.A. Type)
Braking Distance	Less than 6.5 m (21.30 ft.) at 35 km/H (21.9 mile/H)	←	Less than 7 m (23.00 ft.) at 35 km/H (21.9 mile/H)	←
<b>ELECTRICAL</b>				
Ignition	Flywheel magneto	←	←	←
Starting System	Kick starter	←	←	←
Alternator	Flywheel A. C. generator	←	←	←
Battery Capacity	YUASA B60-6 6V-2AH	←	←	←
Spark Plug	C-6 HS, U-24 FS (ND)	←	C-7 HS (NGK), U-24 FS(ND)	C-7 HS (NGK) U-22 FS (ND)
Headlight Bulb	6V-15/15 W	←	6V-25/25 W	6V-15/15 W
Tail/stop Light Bulb	6V-5 W/18 W	←	6V-5.3 W/17 W	6V-5.3 W/17 W
Turn Signal light	←	←	←	←
Turn Signal Indicator Light	—	—	—	—

CT 70K1 (U.S.A. Type)	CT 70K2 (U.S.A. Type)	CT 70K3 (U.S.A. Type)
Less than 7m (23.00ft) at 35km/H (21.9 mile/H)	←	←
Flywheel magneto	←	←
Kick starter	←	←
Flywheel A. C. generator	←	←
YUASA B60-6 6V-2AH	←	6 V 4 AH
C-7 HS (NGK), V-22 FS (ND)	←	←
6 V-15 W/15 W	←	←
6 V-5.3 W/17 W	6 V-3 W/32 W	6 V-5.3 W/25 W
←	6 V-1 W	6 V-18 W Front/Rear
6 V-1.5 W	6 V-1.5 W	6 V-1.5 W

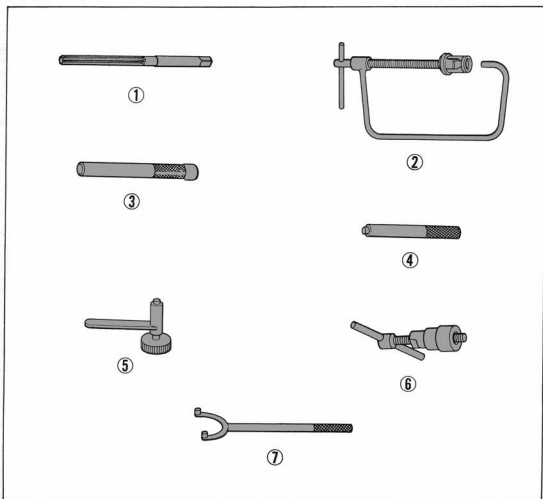

Ref No	Tool No	Description	Remarks
1	07984-0980000	Valve Guide Reamed 5.48 mm dia	Commonly used with C70
2	07957-3290000	Valve Spring Compressor	
3	07942-1180100	Valve Guide Driver	
4	07942-3290100	Valve Guide Remover	
5	07908-0010000	Tappet Adjust Wrench	
6	07933-0010000	Flywheel puller	
7	07923-0400000	Clutch Outer Holder	

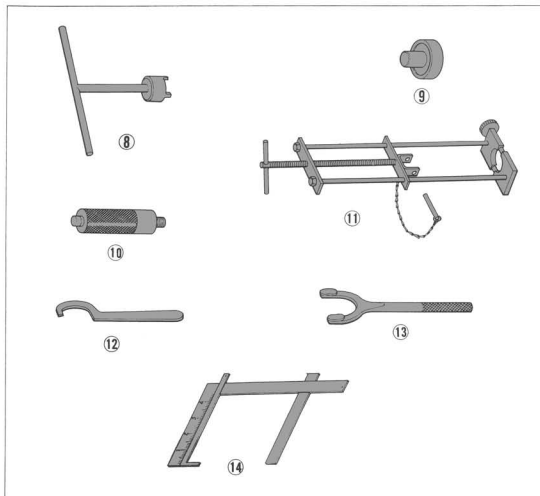

Ref No	Tool No	Description	Remarks
8	07916-2830000	16 mm Lock Nut Wrench	Commonly used with SS50
9	07945-0980000	Bearing Driver Attach	
10	07949-3000000	Bearing Driver Handle	
11	07959-3290000	Rear Cushion Dis/assembly Tool	
12	07902-0010001	Pin spanner 36 mm	
13	07925-0010001	Flywheel Holder	Commonly used with C70
14	07401-0010000	Fuel Level Gauge	

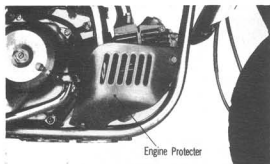

Fig. 1

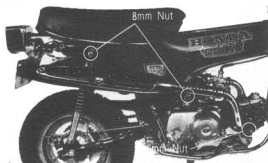

Fig. 2



Fig. 3

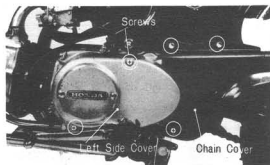

Fig. 4

### 3. ENGINE

#### 3.1 Engine Removal and Installation

##### Engine Removal

1. Drain the engine oil by removing the drain plug and filler cap. Drain the oil while the engine is warm to assure complete draining.
2. (CT70, K1, K2, K3, CT70 H, HK1)  
Remove the engine protector by removing the two fixing bolts. (Fig. 1)
3. Remove the two 8 mm nuts as shown in Fig. 2 and detach the muffler by removing the two 6 mm fixing nuts.
4. Remove the spark plug.
5. Disconnect the throttle wire from the carburetor throttle valve.
6. (CT70, K1, K2, K3/CT70 H, HK1)  
Remove the crankcase protector from the frame the top by removing four bolts. (Fig. 3)
7. Remove the chain case cover by removing the three screws.
8. Remove the left side cover by removing the two screws. (Fig. 4)
9. Disconnect the drive chain at the joint.

10. (CT70, K1, K2, K3/CT70 H, HK1)  
Remove the crankcase protector from the engine at the bottom by removing the two bolts. (Fig. 5)
11. Remove the step bar by removing the two bolts. (Fig. 5)

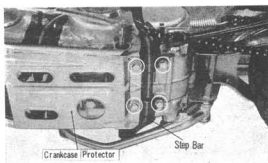

Fig. 5

12. Hook the brake pedal spring to the top to simplify engine removal. (Fig. 6)
13. Remove the two 6 mm bolts and disconnect the intake pipe from the cylinder head intake flange.
14. The engine can then be separated from the frame, by drawing out the two 8 mm engine mounting bolts. (Fig. 6)

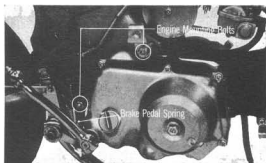

Fig. 6

#### Engine Installation

1. Perform the engine installation in the reverse order of removal.
2. The drive chain should be connected so that the closed end of the link clip faces the normal chain rotation.



Fig. 7

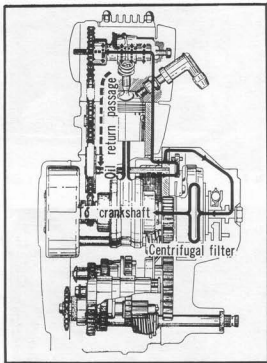

Fig. 8

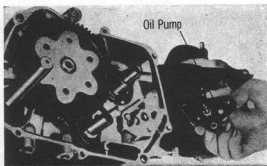

Fig. 9

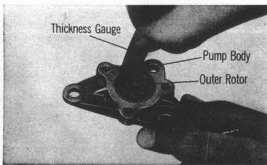

Fig. 10

### 3.2 Lubrication System (Oil Pump)

#### Description

The engine oil from by the trochoid pump is diverted into two routes. (Fig. 8)

#### Route one:

Oil is sent through the right crankcase→right crankcase cover→centrifugal filter→connecting rod large end rollers.

#### Route two:

Oil is sent through the cylinder stud bolt→rocker arm side cover→camshaft profiles and bearing→valve mechanism.

#### Disassembly

1. Unscrew the right crankcase cover mounting screws the cover.
2. Remove the clutch outer cover.
3. Unscrew the 14 mm clutch lock nut and washer. Remove the clutch assembly.
4. Loosen the three 6 mm oil pump mounting bolts and remove the oil pump assembly.
5. Loosen the three cross screws attaching the oil pump cover. The oil pump can then be disassembled (Fig. 9).

#### Inspection

1. Turn the oil pump drive shaft by hand to make sure it turns smoothly.
2. Measuring the clearance between the outer rotor and the pump body.  
Insert the thickness gauge between the outer rotor and the pump body (Fig. 10).

mm (inch)

Standard Value	Serviceable Limit
0.10~0.15 (0.004~0.006)	Replace if over 0.20 (0.0079)



- Measuring the end clearance of the rotor. Place a straight edge across the pump housing and check the clearance of the rotor with a thickness geuge (Fig. 11).

mm (inch)	
Standard Value	Serviceable Limit
0.02~0.07 (0.0008~0.0027)	Replace if over 0.12 (0.0047)

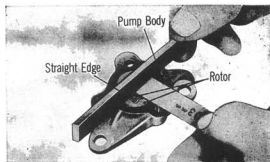

Fig. 11

### Reassembly

Perform the reassembly in the reverse order of disassembly the following items (Fig. 12):

#### Note:

- Clean Parts thoroughly before assembling.
- After completing pump reassembly, check to make sure that the pump is operating smoothly by turning the shaft by hand before mounting the pump in the crankcase.

## 3.3 Cylinder and Cylinder Head

### Description

The cylinder head is aluminum alloy to improve the cooling effect. The cylinder is cast iron to provide good against wear high temperature and pressure.

### Disassembly

- Drain the engine oil by removing the drain plug.
- Unscrew the left crankcase cover mounting screws and remove the cover.
- Loosen the 6 mm hex bolt from the left cylinder head side cover, and remove the side cover. Loosen the two cross screws and remove right cylinder head side cover.
- Remove the flywheel with the flywheel puller. (Tool No. 07933-0010000). Remove the stator assembly (Fig. 13)

#### Note:

- For convenient disassembly, set the piston at the compression top dead center (See Reassembly on page 20)

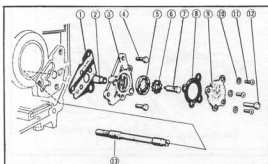

- Oil pump body gasket
- Oil pump dowl pin
- Oil pump body
- 6 mm hex bolt
- Oil pump outer rotor
- Oil pump inner rotor
- Oil pump drive shaft
- Oil pump cover gasket
- Oil pump cover
- 5 mm spring washer
- 5 mm cross screw
- 6 mm hex bolt
- Cam chain guide sprocket spindle

Fig. 12



Fig. 13

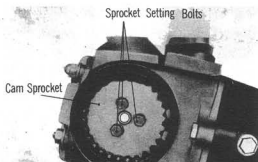

Fig. 14

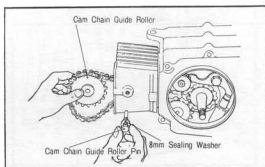

Fig. 15

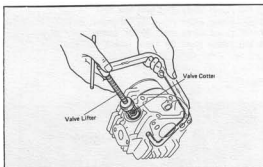

Fig. 16

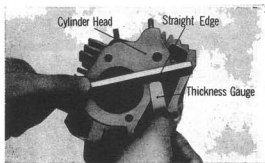

Fig. 17

- Loosen the three cam sprocket mounting bolts and remove the cam sprocket from the camshaft (Fig. 14).

- Unscrew the four cylinder head hold-down nuts and 6 mm hex bolt and separate the cylinder head from the cylinder.
- Loosen the cam chain guide roller pin and remove the cam chain guide roller from the cylinder (Fig. 15).
- Unscrew the cylinder mounting bolt (1 each) and remove the cylinder.
- Disassemble the valve rocker arm and the camshaft from the cylinder head.  
Use the 6 mm bolt for pulling the rocker arm pin out.

- Disassemble the valve with the valve removal tool (Tool No. 07957-3290000) (Fig. 16).

#### Inspection

- Inspecting the cylinder head machined gasket surface.

Place a straight edge across the machined gasket surface and measure the clearance between the straight edge and the machined surface with a thickness gauge. If the clearance exceeds 0.05 mm (0.002 in), the cylinder head should be repaired or replaced (Fig. 17).

To perform the repair, place a sheet of fine grit emery paper on the flat surface, and rework the cylinder head. The condition of the machined surface can be checked by using prussian blue or red lead (Fig. 18).

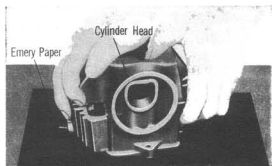

Fig. 18

2. Inspect the valve seat.

**STANDARD:** 1.0-1.3 mm  
(0.04-0.05 in.)

**SERVICE LIMIT:** 2.0 mm (0.08 in.)

If the seat is too wide, too narrow, or has low spots, the seat must be ground. If the valve seats must be ground, the use of a power grinder is recommended.

Valve Seat Outside Diameter	mm (inch.)	
	Intake	Exhaust
ST 50	0, 889 (22, 5)	0, 767 (19, 5)
ST 70 CI 70, K1, K2, K3 CI 70H, HK1	0, 964 (24, 5)	0, 846 (21, 5)

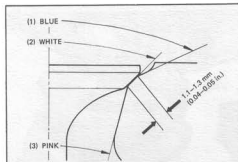

Fig. 19

**Caution:**

Use the valve seat grinder (Tool No. 07782-0020000, A set) to correct the valve seat width and contact.

Read valve seat grinder the instructions carefully.

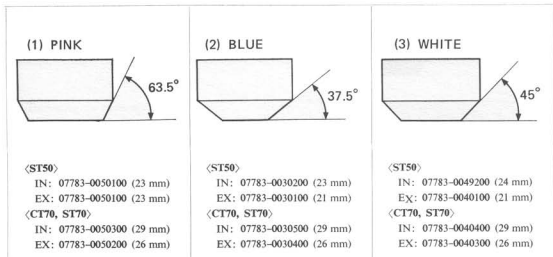

Fig. 20-1

Fig. 20-2

Fig. 20-3

If the valve seat has been repaired or the valve replaced, the valve must be lapped to the seat. To lap the valve, apply a small amount of lapping compound to the valve contact surface and rotate the valve back and forth against the seat with a suction cup tool; lifting the valve off the valve seat occasionally. After valve lapping is completed, wash the lapping compound off thoroughly from both the valve seat and face. Check the valve seating with prussian blue or red lead to assure that a good seat has been obtained.

**Note:**

1. Apply a small amount of oil to the valve stem when inserting the valve into the guide.
2. After the valve has been assembled into the cylinder head, check the valve sealing by pouring a small quantity of engine oil into the combustion chamber until the valve heads are covered and then apply compressed air at 2 kg/cm<sup>2</sup> (28.4 psi) alternately into intake and exhaust ports and check for any bubbles around the valve seats. If there are no bubbles, the valves are seating properly.

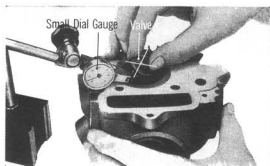

Fig. 21

3. Measuring valve stem and valve guide wear. Place a dial gauge against the valve stem and move the valve sideways and fore and aft. The amount of wear in any direction will be indicated on the gauge (Fig. 21).

mm (inch)		
Item	Standard Value	Serviceable Limit
Intake	0.01~0.03 (0.0004~0.0012)	Replace if over 0.08 (0.0032)
Exhaust	0.03~0.05 (0.0012~0.002)	Replace if over 0.10 (0.004)

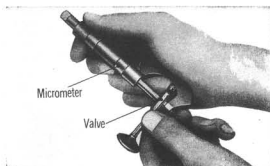

Fig. 22

4. Measuring the valve dimension. The valve stem diameter is measured with a micrometer. (Fig. 22).

mm (inch)		
Item	Standard Value	Serviceable Limit
Intake	5.455~5.465 (0.2148~0.2187)	Replace if under 5.40 (0.2126)
Exhaust	5.435~5.445 (0.2070~0.2109)	Replace if under 5.38 (0.2048)



Fig. 23

5. Replacing the valve guide  
If the valve guide is worn excessively and requires replacement, follow the procedure below:
  - a. Remove the valve guide from the cylinder head with the valve guide remover (Tool No. 07942-3290100) (Fig. 23).
  - b. Install the new valve guide with the valve guide driver (Tool No. 07942-1180100), and carefully drive the guide into the head. The replacement valve guide should be oversized.

- c. After the new valve guide has been installed, it must be reamed to the proper finish size with a guide reamer (Tool No. 07984-0980000). Exercise care when using the reamer and occasionally apply a small amount of oil to the reamer when it becomes difficult to use. Pull the reamer out and remove the metal chip before continuing to ream. The standard valve guide inside diameter is 5.475-5.485 mm (0.2156-0.2159 in.). (Fig. 24).



Fig. 24

6. Inspecting the valve spring  
Measure the valve spring free length with a vernier caliper. (Fig. 25)

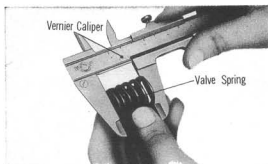

Fig. 25

mm (inch)

Item	Standard Value	Serviceable Limit
Inner valve spring free length	25.1 (0.988)	Replace if under 23.9 (0.941)
Outer valve spring free length	28.1 (1.106)	Replace if under 26.9 (1.059)
Inner valve spring compression	2.45~2.75 kg/22.7 (5.37~6.03 lb/0.894 in)	Replace if under 2.0 kg/22.7 (4.41 lb/0.894 in)
Outer valve spring compression	6.65~7.75 kg/24.9 (14.66~17.09 lb/0.980 in)	Replace if under 4.6 kg/24.9 (10.14 lb/0.980 in)

7. Inspecting the camshaft  
Measure the cam lift with a micrometer (Fig. 26).  
mm (inch)

Item	Standard Value	Serviceable Limit
Base circle	21.0 (0.827)	Replace if under 20.8 (0.819)
Cam lift (including the base circle)	26.076 (1.0266)	Replace if under 25.8 (1.012)

**Valve Timing**

Intake opens	5° BTDC
Intake closes	20° ATDC
Exhaust opens	25° BBDC
Exhaust closes	5° BTDC

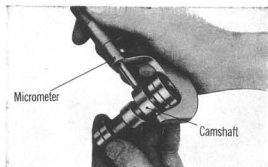

Fig. 26

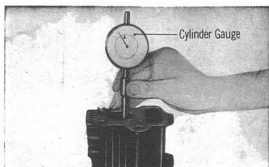

Fig. 27

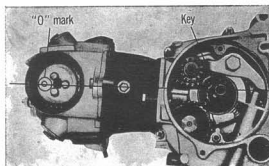

Fig. 28

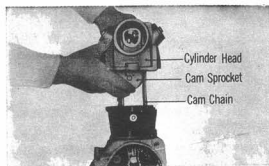

Fig. 29

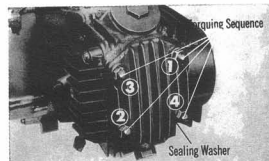

Fig. 30

8. Measuring the inside diameter of the cylinder  
Use a cylinder gauge and measure the inside diameter of the cylinder at the top, center and bottom in both X and Y axes. If the cylinder is excessively worn, it should be either rebored or replaced with a new cylinder depending upon the extent of wear (Fig. 27).

	Standard Value	Serviceable Limit
ST 50	39,005~39,015 (1,5356~1,5360)	39,1 (1,539)
ST 70 CT70K1, K2, K3 CT 70 H, HK1	47,005~47,015 (1,8506~1,8510)	47,1 (1,854)

**Note:**

When reboring the cylinder, it must be rebored to oversize units of 0.05mm (0.010 in) to a maximum of 1.0mm (0.040 in). The piston and piston ring sets are those oversizes only.

**Reassembly**

Perform the reassembly in the reverse order of disassembly described in page 13 section 5.3. Follow the procedure below for timing the valves. Position the key of the left crankshaft so that it is pointing toward the cylinder head, and position the cam so that the "O" marking on the cam sprocket is at the top (Fig.28).

**Note:**

- When installing the cylinder head, the cam sprocket must be contained within the cylinder head (Fig. 29).  
Do not forget to install the respective gaskets, dowel pins and rings.
- The position of the cylinder head nuts is ①, ②, and ③ for the blind nut, and ④ for the plain nut. Do not omit the sealing washer on the ④ position (Fig. 30).
- When torquing down the cylinder head, tighten the nuts uniformly in a diagonal sequence as shown in Fig. 30 and torque to the final specified torque value of 90-120 kg-cm (6.5-9 ft-lb).

### 3.4 Cam Chain Tensioner

A constant force is applied to the cam chain automatically by the hydraulic and spring-operated cam chain tensioner. (Fig. 31).

#### Check valve inspection

Push the pushrod and check to see if oil is leaking from the check valve. If the oil is leaking, it is probably due to dirt in the valve. Clean the valve by blowing out with compressed air. If the oil is dirty, it should be changed. Check the guide rollers for wear.

The manual cam chain tensioner is equipped on the CT70-70H K1, K2 and K3 models.

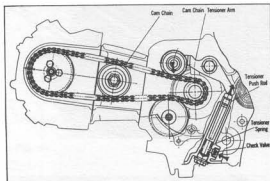

Fig. 31-A

#### Cam Chain Adjustment

1. To adjust, loosen the lock nut and back off the tensioner adjusting bolt approximately 1/2 turn.
2. If the chain is still noisy after adjusting, loosen the 14 mm sealing bolt located at the left lower side of the crankcase and tighten the tensioner bolt gradually until the chain becomes quiet. Upon completing the adjustment, tighten the tensioner adjustment, tighten the tensioner adjusting bolt, lock nut and 14 mm sealing bolt securely.

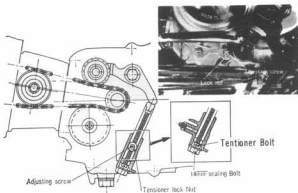

Fig. 31-B

### 3.5 Piston and Piston Rings

#### Description

The piston is made of special SAE 332 aluminum alloy to minimize material deformation caused by high temperature and also because of its good wear resistant qualities. The piston rings specially should be highly resistant and therefore, they are hard chrome plated or wet honed to give it the desired characteristics.

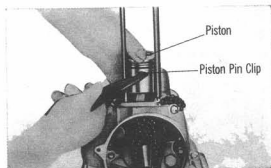

Fig. 32



Fig. 33

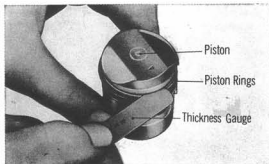

Fig. 34

### Disassembly

1. The piston is disassembled from the connecting rod by first removing the piston pin clip and then the piston pin (Fig. 32).

#### Note:

When removing the piston pin clip, place a rag under the piston so that the clip will not fall into the crankcase if it should accidentally be dropped.

2. To remove the piston rings from the piston, it is recommended that the piston ring remover be used, however, if it is not available, they can be removed by hand, but care should be exercised so that they are not broken.

### Inspection

1. Measuring the piston  
Measure the piston diameter at the piston skirt at right angle to the piston pin axis using a micrometer (Fig. 33).

mm (inch)		
	Standard Value	Serviceable Limit
ST 50	38, 98~39, 00 (1, 5346~1, 5354)	Replace if under 38, 9 (1, 531)
ST 70 CT170, K1, K2, K3 CT70 H, HK1	46, 98~47, 00 (1, 8492~1, 8500)	Replace if under 46, 9 (1, 847)

2. Measuring the piston ring end gap  
Insert the piston ring into the cylinder bottom end and measure the ring end gap with a thickness gauge

mm (inch)		
Item	Standard Value	Serviceable Limit
Top and second ring	0, 15~0, 35 (0, 0059~0, 0138)	Replace if over 0, 5 (0, 0197)
Oil ring	0, 15~0, 40 (0, 0059~0, 01575)	Replace if over 0, 5 (0, 0197)

3. Measuring the piston ring side clearance  
Measure the clearance between the piston ring and piston land with a thickness gauge (Fig. 34).

mm (inch)		
Item	Standard Value	Serviceable Limit
Top and second rings	0, 015~0, 045 (0, 0006~0, 0018)	Replace if over 0, 12 (0, 0047)
Oil ring	0, 010~0, 045 (0, 0004~0, 0018)	Replace if over 0, 12 (0, 0047)



- Piston and piston rings are available in four standard oversizes of 0.25mm (0.01 in) to 1.0mm (0.04 in).

#### Reassembly

Perform the reassembly in the reverse order of disassembly as described on page 24.

#### Note:

- When assembling the piston to the connecting rod, make sure that the arrow mark on the piston head is pointing down (Fig. 35)
- Apply oil when mounting the piston rings and piston pin.  
Make sure that the rings move smoothly in the ring groove, and that the ring end gaps do not form a straight line.
- Check the top surface of the ring. The rings should be mounted so that the R (or T) mark faces the top.
- Use a new piston pin clip when fixing the piston pin to the piston.

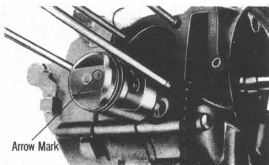

Fig. 35

### 3.6 Clutch

#### Description

The clutch is the conventional wet two-disc clutch which is automatically operated according to the centrifugal force generated by the engine rotation. The CT 70 H, HK1 incorporates the manual type clutch.

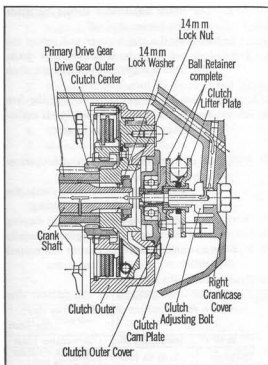

Fig. 36-1 ST 50-70-CT 70 CT 70, K1, K2, K3 Clutch assembly

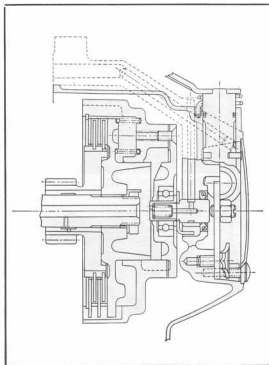

Fig. 36-2 CT 70 H, HK1 Clutch assembly

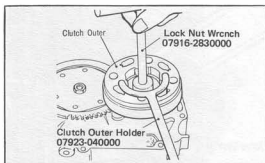

Fig. 37

**Disassembly**

1. Loosen the right crankcase cover retaining screws and remove the cover.
2. Remove the clutch outer cover.
3. Straighten the tab on the lock washer, and using the clutch outer holder (Tool No. 07923-040000) and lock nut wrench (Tool No. 07916-2830000), loosen the lock nut and remove the clutch assembly (Fig. 37). The clutch is then disassembled.

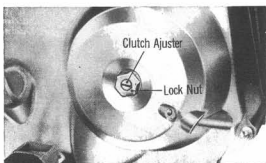

Fig. 38-1 (ST 50-70, CT 70, K1, K2, K3)  
 ① Adjusting screw ② Lock nut

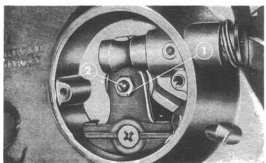

Fig. 38-2 (CT 70 H, CT 70, HK1)  
 ① Adjusting screw ② Lock nut

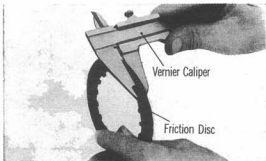

Fig. 39

**Inspection And Adjustment**

1. Clutch adjustment.
  - a. The clutch must be adjusted with the engine off. Loosen the adjuster lock nut.
  - b. Turn the adjuster clockwise about one turn. Do not turn excessively.
  - c. Slowly turn the adjuster counterclockwise and stop when the adjuster to turn heavy.
  - d. From this point, back off the adjuster in the clockwise direction 1/8 to 1/4 turn, and tighten the lock nut (Fig. 38-1).
1. Clutch adjustment (CT70H, HK1)
  - a. The clutch adjustment should be made with the engine shut off.
  - b. Remove the clutch cover and loosen the lock nut. Turn the adjusting screw clockwise until a slight resistance is felt, then back off 1/4 turn (Fig. 38-2).
  - c. Adjust the clutch cable so that the free play of 10-20 mm (0.4-0.8 in.) is available at the end of the clutch lever.

Check to make sure that the clutch operates properly after adjustment.

- The engine should start easily with the kick starter without the clutch slipping.

- When changing gear, the clutch slipping should be smooth and light, especially when shifting down in gear to the neutral position.

2. Measuring the friction disc  
 Measure the thickness of the friction disc with a vernier caliper (Fig. 39).

		mm (inch)
Item	Standard Value	Serviceable Limit
Thickness	3.50 (0.138)	Replace if under 3.10 (0.122)
Flatness	—	Replace if over 0.15 (0.006)

3. Inspecting the clutch spring  
Measure the spring free length with a vernier caliper (Fig. 40).

		mm (inch)	
	Item	Standard Value	Serviceable Limit
ST 50	Free length	24, 8 (0, 976)	Replace if under 23, 8 (0, 937)
ST 70 CT 70	Free length	21, 4 (0, 843)	Replace if under 20, 4 (0, 803)
CT 70H	Free length	20 (0, 787)	Replace if under 19 (0, 748)

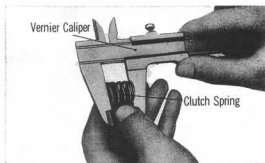

Fig. 40

#### Reassembly

Perform the reassembly in the reverse order of disassembly described on page 23.

#### Note:

**Bend the lock tab positively in the clutch lock nut slot.**

### 3.7 Crankshaft

#### Description

The connecting rod is assembled on the crank pin. The bearing at the large end is lubricated by the pressurized oil which flows through the crankshaft (Fig. 41).

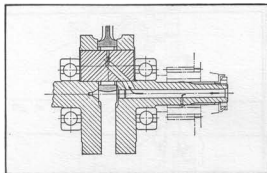

Fig. 41 Oil flow

#### Disassembly

1. Remove the cylinder head and cylinder according to the procedure on page 15.
2. Remove the clutch assembly according to the procedure on page 23.
3. Remove the primary driven gear and kick starter spring.
4. Remove the oil pump.
5. Remove the gear shift stopper and plate.
6. Loosen the left crankcase cover screws and remove the cover, flywheel, stator and cam chain.
7. Pull the rubber plug off and remove the gear shift drum stopper bolt.
8. Remove the final drive sprocket.
9. Remove the right crankcase.
10. Lift the crankshaft assembly out from the case.

#### Inspection

1. Measuring the crankshaft balance.  
Support the crankshaft on V-blocks at the bearings. Rotate the crankshaft and measure the amount of runout at both ends of the crankshaft with a dial gauge (Fig. 42).

		mm (inch)	
	Item	Standard Value	Serviceable Limit
Left end, at 30 (1, 2) from the weight	}	0, 015 (0, 0006)	Replace or repair if over 0, 05 (0, 002)

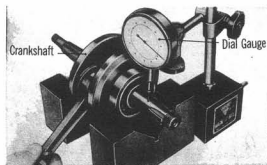

Fig. 42

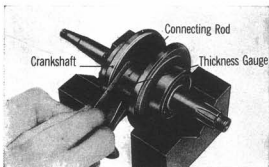

Fig. 43

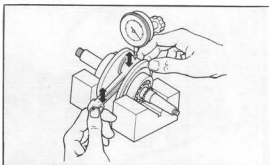

Fig. 44

2. Measuring the connecting rod side play.  
Measure the amount of connecting rod side play using a thickness gauge (Fig. 43).

mm (inch)	
Standard Value	Serviceable Limit
0.1~0.35 (0.004~0.014)	Replace if over 0.80 (0.0315)

3. Measuring the radial clearance of the connecting rod large end bearing.  
Measure the amount of clearance at the connecting rod large end with a dial gauge (Fig. 44).

mm (inch)	
Standard Value	Serviceable Limit
0.12 max. (0.0005 max.)	Replace if over 0.5 (0.002)

#### Reassembly

Perform the reassembly in the reverse order of disassembly.

### 3.8 Transmission

#### Description

The transmission incorporates the constant-mesh 3-speed gears.  
The CT 70 H incorporates the constant-mesh 4-speed transmission.  
The power train of the transmission is shown below.

(ST 50-70, CT 70)

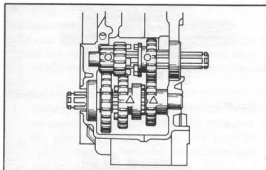

Fig. 45 Neutral position

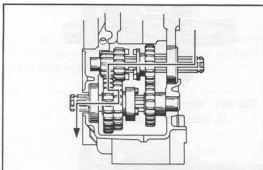

Fig. 46 Low gear position

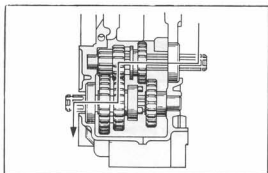

Fig. 47 Second gear position

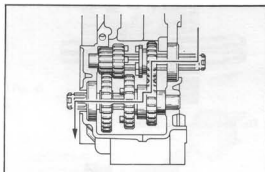

Fig. 48 Third gear position

(CT 70 H · HK1, CT70 · K1 · K2 · K3)

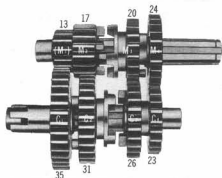

Fig. 48-1 Neutral position

① Mainshaft ② Countershaft

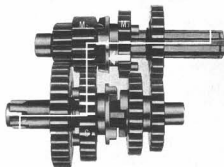

Fig. 48-3 Second gear position

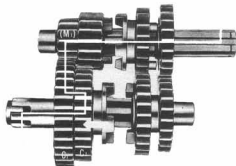

Fig. 48-2 Low gear position



Fig. 48-4 Third gear position

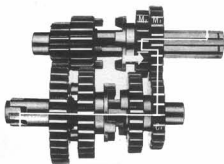

Fig. 48-5 Top gear position

**Disassembly**

Perform the disassembly according to section Crankshaft Disassembly. Remove the right crankcase and separate the mainshaft assembly, countershaft assembly and the gear shift fork assembly as a unit.

**Inspection**

mm (inch)

Item	Standard Value	Serviceable Limit
Gear backlash	0.09~0.18 (0.0035~0.0070)	Replace if over 0.25 (0.010)
Clearance between gear and shaft (mainshaft and gears)	0.02~0.06 (0.001~0.0025)	Replace if over 0.1 (0.004)
Clearance between gear and shaft (Countershaft and gears)	0.032~0.077 (0.0013~0.0030)	Replace if over 0.1 (0.004)

### Reassembly

Perform the reassembly in the reverse order of disassembly.

#### Note:

1. Note the right position of each component referring to Fig. 47~50.
2. Replace all circlips with new ones.
3. After combining the right crankcase with the left crankcase, check the transmission if it engages smoothly in gears.

## 3.9 Gear Shift Mechanism

### Description

The gear spindle arm which is connected to the gear shift spindle rotates the gear shift drum and this causes the gear shift fork to move left and right in the drum groove. The gear shift fork is controlled by the groove in the drum and this in turn causes the gears to slide and change gears.

### Disassembly

1. Refer to the section on crankshaft disassembly on page 24. By removing the right crankcase, the gear shift drum and the fork assembly can be removed with the transmission gear as a complete unit.

### Inspection

1. Measuring gear shift fork end thickness.  
The shift fork end thickness is measured with a micrometer (Fig. 49).

mm (inch)		
Item	Standard Value	Serviceable Limit
Right side	5.5~6.3 (0.217~0.248)	Replace if under 5.3 (0.209)
Left side	4.5~5.3 (0.177~0.209)	Replace if under 4.3 (0.169)

2. Measuring the inside diameter of the gear shift fork.

The inside diameter of the gear shift fork is measured with a cylinder gauge or an inside micrometer (Fig. 50).

inch (mm)	
Standard Value	Serviceable Limit
34.0~34.03 (1.3385~1.3395)	Replace if over 34.2 (1.347)

3. Measuring the outside diameter of the gear shift drum  
The diameter is measured with a micrometer (Fig. 51).

mm (inch)	
Standard Value	Serviceable Limit
33.95~33.98 (1.3366~1.3377)	Replace if under 33.9 (1.335)

4. Check the fork end for bending.

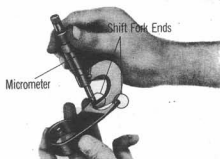

Fig. 49

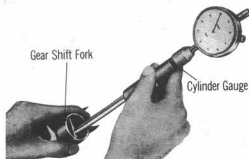

Fig. 50



Fig. 51

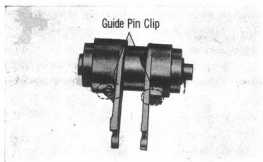

Fig. 52



Fig. 53

**Reassembly**

Perform reassembly in the reverse order of disassembly. Note the following items:

1. Make sure that the guide pin and guide pin clip are properly installed on the gear shift drum for both the right and left shift forks (Fig. 52).
2. Apply screw locking agent to the stopper Plate fixing screw (Fig. 53).
3. Check that the transmission gears engage smoothly.

**3.10 Kick Starter**

Stepping on the kick starter will move the pinion, which is locked by the acme threads, to the left and meshed with the countershaft low gear and transmits the force to the crankshaft to start the engine.(Fig. 54).

**Instruction for assembly**

- 1) After completing the assembly, do not forget to install the circlip. Replace with a new part.
- 2) Assemble the parts in the position shown in the figure below.

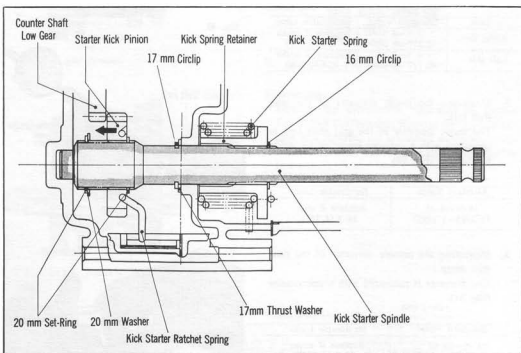

Fig. 54



## 3.11 Carburetor

The carburetor mixes the fuel and air taken into the engine in a correct proportion to produce a mixture and which is further atomized so that it is easily combustible. The carburetor construction is quite the same as that of 50/65 except except that it has a horizontal drought direction venturi unlike 50/65 series. For move information on this carburetor, the 50/65 shop manual should be referred to.

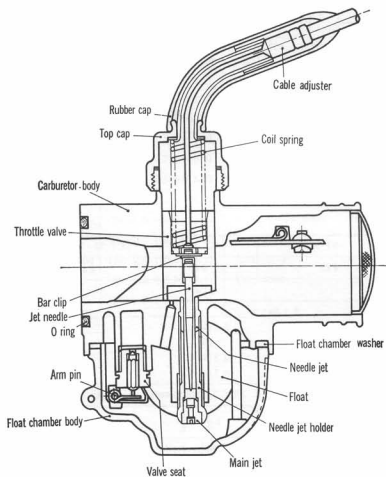

Fig. 55

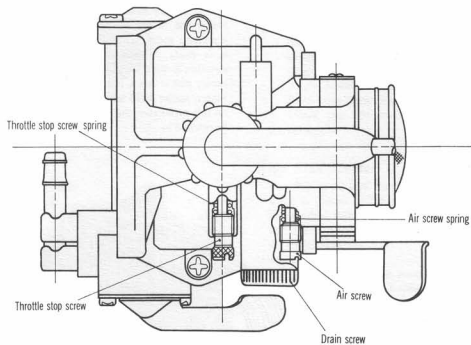

Fig. 56

The carburetor specification is summarized as below.

Type	ST 50	ST 70	CT 70 - 70 H	CT 70 H - HK1 CT 70 - K1 - K2 - K3
Main Jet	№ 62	№ 65	№ 60	№ 58
Air Jet	№ 150			
Air Bleed	AB <sub>1</sub>	0, 5 dia × 2	0, 6 dia × 2	
	AB <sub>2</sub>		0, 5 dia × 2	
	AB <sub>3</sub>		Nil	
	AB <sub>4</sub>		0, 5 dia × 2	
Needle Jet	3°00' 2, 535φ (3 steps)	3°00' 2, 525φ (3 steps)	3°00' 2, 545φ (3 steps)	
Air Screw	$1\frac{5}{8} \pm \frac{1}{8}$	$1\frac{1}{8} \pm \frac{1}{8}$	$1\frac{3}{4} \pm \frac{1}{8}$	
Cutaway	№ 2, 5 (width × depth) 1, 2mm × 0, 2mm			
Carburetor type	1000-550		1000-533	
Slow Jet	AB <sub>1</sub>		Nil	
	AB <sub>2</sub>		0, 9 dia × 2	
	AB <sub>3</sub>	№ 35	0, 9 dia × 2	
	AB <sub>4</sub>		0, 9 dia × 2	

	ST 50	ST 70	CT 70 · K1 · K2 · K3 CT 70 H · HK1
Valve Seat	1.0 dia		
Pilot Outlet	0.8 dia P=5.7		
Main Bore	13 dia		
Setting Mark	ST 5 B	ST 7 A	AT 70 A
Fuel Level	20		
Needle Jet Holder	5.0 dia		

### 3.12 Tightening Torque Limits

The tightening torque of major engine fastening points is specified in the following table.

Bolts And Nuts	Tightening Torque		Bolts And Nuts	Tightening Torque	
	kg-cm	Lb. ft		kg-cm	Lb. ft
R & L Crankcase	80~110	( 5.8~ 8.0)	Shift drum stopper plate	90~130	( 6.5~ 9.4)
Cam chain guide roller pin	70~130	( 5.1~ 9.4)	Shift drum stopper	100~160	( 7.2~11.6)
Cylinder head stud nut	90~120	( 6.5~ 8.7)	Clutch nut	380~450	(27.5~32.5)
Cylinder side bolt	80~110	( 5.8~ 8.0)	R. Crankcase cover	80~120	( 5.8~ 8.7)
Cylinder head side bolt	100~150	( 7.2~10.8)	Stater	80~120	( 5.8~ 8.7)
Cam sprocket	50~ 90	( 3.6~ 6.5)	Flywheel	330~380	(23.9~27.5)
Cylinder head R side cover	70~ 90	( 5.1~ 6.5)	Drive sprocket	90~150	( 6.5~10.8)
Cylinder head L side cover	80~120	( 5.8~ 8.7)	L. Crankcase cover	80~110	( 5.8~ 8.0)
Tappet adjustment	70~100	( 5.1~ 7.2)	Drain cock bolt	250~450	(18.1~25.3)
Cam chain tensioner push rod	150~250	(10.8~18.1)	Spark plug	110~150	( 8.0~10.8)
Oil pump	80~120	( 5.8~ 8.7)	Carburetor	90~140	( 6.5~10.1)
Shift drum side bolt	90~150	( 6.5~10.8)			

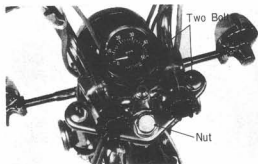

Fig. 57



Fig. 58



Fig. 59



Fig. 60

## 4. FRAME

### 4.1 Handle Bar

#### a. Handle Bar Construction

The steering handle is a steel pipe. For easy handling and transportation, the steering handle is equipped with a fold down device. It is also designed so that the steering handle can be disassembled from the frame by removing the two bolts and a nut (Fig. 57).

The steering handle knob can be folded down by releasing the two handle holder knobs as shown in (Fig. 58).

#### b. Disassembly

- (1) After releasing two handle holder knobs, remove the two stopper nuts from the fork top bridge using the special tool, (07902-0010000)
- (2) Remove two bolts and 29 mm nut steering nut (Fig.57)
- (3) Remove the headlight assembly and disconnect all electrical leads after removing the headlight cover by removing the screw at the bottom (Fig. 59).
- (4) Uncouple the speedometer cable and disconnect the front brake cable.
- (5) Disconnect the throttle cable by removing the carburetor cap and disengage the cable from the throttle valve (Fig. 60).
- (6) The steering handle can then be removed from the frame with the steering bracket, (Fig. 57).

### c. Inspection

- (1) Inspect the throttle and front brake cables for damage and breakage on both the inner cable and outer casing. Check for proper operation. Lubricate before installation.
- (2) Check the handle levers for proper operation.
- (3) Inspect the handle pipe for bending and twisting.
- (4) Check all switches for proper function and the electrical leads for damaged covering.

### d. Reassembly

- (1) Reinstall all the wires, speedometer and leads on the specified locations and fix in place with handle fixing bolts and nuts.
- (2) Reinstall the front brake cable, speedometer cable and throttle cable.
- (3) Reconnect all connectors from the electrical leads and reinstall the headlight.

**Note:**

**When installing the steering handle, do not pinch the cables and leads.**

## 4.2 Front Fork

The steering stem of these models incorporates a ball bearing at the top and bottom. It excels in steerability and stability for both high and low speeds. The steering stem is unitized with the frame and incorporates ball bearings which are installed on the frame head pipe. They serve a vital function since it is the rotating shaft of which the head pipe is the axis.

### a. Disassembly

- (1) Remove the steering handle (See page 34).
- (2) Remove the front wheel (See page 40).
- (3) Remove the fork top bridge by unscrewing the steering head stem nut and two 8 mm bolts.
- (4) Unscrew the steering head top nut with the hook spanner (special spanner) (Tool No. 07902-0010000) and slide the front fork out the bottom with the front fender, headlight casing and horn.

**Caution:**

**When removing the front fork, do not drop the #6 steel balls (Fig. 61).**

### b. Inspection

- (1) Inspect the #6 steel balls for cracks and wear. (Fig. 62).
- (2) Inspect the steering stem for bending and twisting.
- (3) Inspect the steering bottom and top cone races and ball races, for scratches, wear and streaks.



Fig. 61



Fig. 62

### c. Reassembly

- (1) Wash the cone races, ball races and the steel balls, and pack with new grease. Use recommended fiber grease.
- (2) In order to provide proper steerability, the steering stem nut should be torqued as follow.
  1. Fasten the nut completely until it is locked.
  2. Release the nut about 45 degrees counterclockwise.
  3. Fasten it by hand until it is locked again.
  4. Release it by hand. Proper steerability will then be provided.

## 4.3 Front Cushion

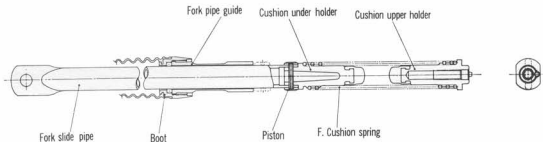

Fig. 63

### a. Front Cushion Construction

The front wheel axle and axle nut assembles the cast aluminum hub consisting of two sets of 63010 radial ball bearings and an integral brake drum to the front brake panel which contains the brake shoes and speedometer gear. The front cushion, unlike the other types with a damper inside, has only a coil spring for cushion effect, considering the usage of this type.

### b. Disassembly

- (1) Remove the front wheel (see page 35).
- (2) Remove the front fork top bridge (see page 30).
- (3) Both front cushions can be pulled out from the bottom of the front cushion housing incorporated on the steering stem after releasing the front fork guide cap (Fig. 64) shows the front cushion assembly.



Fig. 64

- (4) Fix the cushion upper holder with a vise as shown in Fig. 65 and hit the end of the cushion spring with a steel hammer through a driver to remove the spring from the upper holder. Excessive care should be taken not to damage the upper holder because it is aluminum alloy.

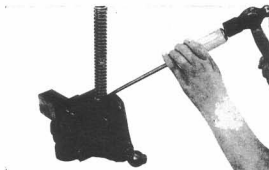

Fig. 65

- (5) The under holder can be separated from the spring in the same way as the upper holder. The piston should be fixed with a vise. The piston is rubber-coated on the exterior. Do not damage it when fixing it with a vise.



Fig. 66

- (6) Pull the pin out that fixes the fork slide pipe, under holder hoder and piston with a pin remover as shown in Fig.67.



Fig. 67

- (7) Fig. 68 shows the disassembled front cushion assembly.

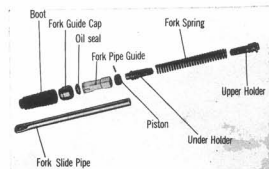

Fig. 68

## c. Inspection

- (1) Contract the front cushion with both hands from the top as it is completely assembled and check to see if it functions properly.
- (2) Check if any noise comes from the cushions by contracting as above.
- (3) Front cushion spring.

Standard Valve	
Load	54 kg/20.8 mm (118.6 lb/2.79 in)
Load	8.2 kg/10.8 mm (18.1 lb/0.43 in)
Free length	148.5 mm

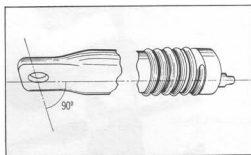

Fig. 69

## 4.4 Rear Cushion

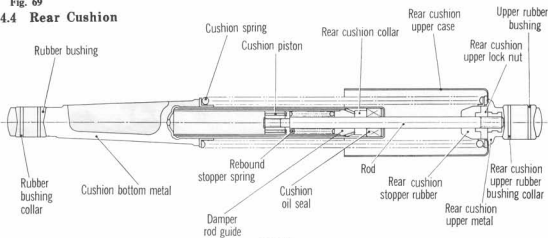

Fig. 70

## d. Reassembly can be performed in the reverse order of disassembly

(Note)

- (1) When assembling the front cushion, assemble it so that the lug on the upper holder is perpendicular to the flat part of the fork slide pipe. (Fig. 69).
- (2) Apply grease inside the cushion housing spring, dust seal, upper and under holders.
- (3) When replacing the spring with a new one, apply grease on the new parts as above.
- (4) When assembling the spring to the upper holder, wrap vinyl tape around the holder.

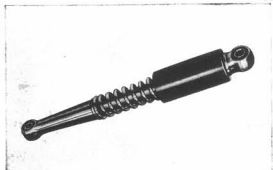

Fig. 71

## a. Rear Cushion Construction

The rear cushion connects the frame with the rear fork and absorbs the shock from the rear wheel.

The coil spring having an uniform pitch is housed in the metal lower case and the upper case which is made of steel pipe, absorbs the shock which comes from the road. The hydraulic damper dampens the reacting extension force. (Fig. 70, 71).



**b. Disassembly**

- (1) Remove the rear cushion assembly by loosening the upper and lower cap nuts.
- (2) Disassemble the rear cushion component parts with the special tool as shown in Fig. 72. (Tool No. 07959-3290000)

**c. Inspection**

- (1) Damping capacity of rear cushion damper 25kg/0.5m/sec (2.79 lb/in/sec.)
- (2) Rear cushion spring

	Standard Value
Free Length	205.9mm (8.11 in.)
Load	14 kg/11.1 mm (30.9 lb/0.43 in.)
Load	63 kg/50 mm (138.9 lb/1.97 in.)
Load	100 kg/68.8 mm (220.5 lb/2.71 in.)

**d. Reassembly**

After reassembly, operate the rear cushion by hand to assure that there is no binding between the spring and the case and no noise comes from the cushion.

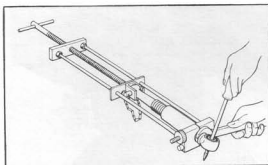

Fig. 72

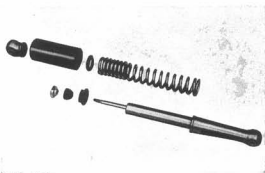

Fig. 73

**4.5 Front Wheel**

Fig. 74



Fig. 75

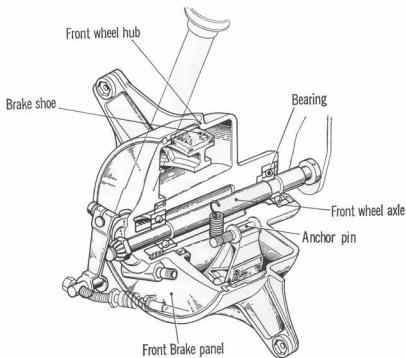

Fig. 76

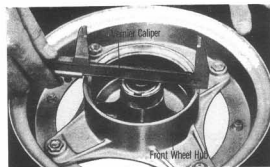

Fig. 77

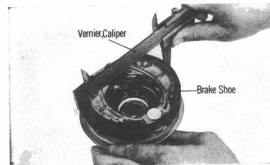

Fig. 78

#### a. Front Wheel Construction

The front wheel consists of the front axle and the axle nut assembling the cast aluminum alloy hub with the cast brake drum and two 63010 ball bearings with the front brake panel consisting of brake shoes and a speedometer gear. Different from the other types of this model, which has wire spokes, a front wheel hub of aluminum alloy cast is directly connected with the combined type of rim. A labyrinth is incorporated in the brake panel and the wheel hub to prevent entry of water and dust into the hub interior.

#### b. Di assembly

- (1) Place an adequate stand under the engine to raise the front wheel.
- (2) Remove the front brake cable and the speedometer cable.
- (3) Remove the axle nut and pull out the front wheel axle shaft. The front brake panel can be removed as a unit.
- (4) The brake shoe is fixed in place with the shoe spring. Spread the brake shoes apart and remove from the panel. (Fig. 75).
- (5) Remove the tire and tube from the speedometer gear from the front brake panel. (Fig. 76).
- (6) Remove the tire and tube from the rim using a tire lever and pull the tube out from the tire.

#### Caution:

When removing the front hub from the rim, be sure to deflate air first, then remove it.

#### c. Inspection

- (1) Check brake drum inside diameter (Fig. 77).  
mm (inch)

	Standard Value	Serviceable Limit
Inside Diameter	109.8~110.2 (4.25~4.41)	Replace if over 110.5 (4.35)

- (2) Check brake shoe outside diameter. (Fig. 78).  
mm (inch)

	Standard Value	Serviceable Limit
Outside Diameter	109.2~109.5 (4.173~4.29)	Replace if under 105.5 (4.153)

- (3) Check front axle diameter for bending.  
(Fig. 79)

mm (inch)		
	Standard Value	Serviceable Limit
Diameter	9.950~10.0 (0.398~0.400)	—
Bend	0.2 (0.008 in)	Repair or replace if over 0.5 (0.02)

- (4) Check the bearings for wear and roughness.  
Replace any defective bearing.

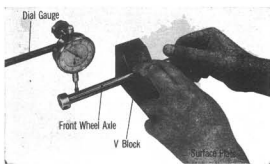

Fig. 79

#### d. Reassembly

- (1) After reassembling the tire, fill it with air to about 1/3 of the specified pressure. Tap the tire all around with a soft hammer to eliminate any tube twisting or pinching. (Fig. 80)

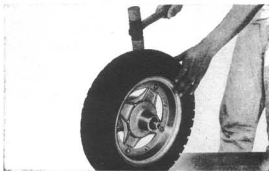

Fig. 80

- (2) The valve stem must be pointed toward the axle. An improperly seated valve stem may cause an air leak. (Fig. 81)

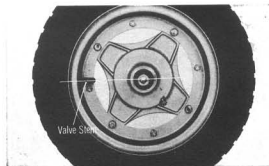

Fig. 81

- (3) Wash the old grease from the wheel hub and the bearing, and pack with new grease. Fill the hub with grease and install the distance collar. Install the 63010 ball bearings use bearing Dr. Attach (Fig. 82) (Tool No. 07945-0980000) with bearing Driver Handle (Tool No. 07949-3000000).
- (4) After installing the bearings, reassemble the front wheel and the brake shoe in the reverse order of disassembly.
- (5) Install the brake cable and adjust the brake lever play.

#### TIRE AIR PRESSURE

Front air pressure

ST50, 70, CT70, CT170H

1.1~1.3 kg/cm (15.65~18.5 Psi)

CT170K1, K2, K3, 1.2 kg/cm (17 Psi)



Fig. 82

## 4.6 Rear Wheel

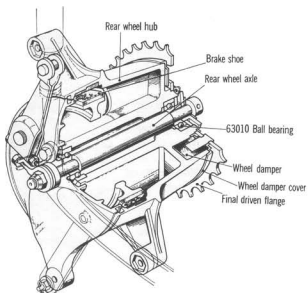

Fig. 83

## a. Rear wheel construction

The rear wheel consists of a cast aluminum alloy rear wheel hub incorporating ball bearings, and a brake panel. A tire size (ST 50/70 3.50-10-2PR, CT 70, K1, K2, K3/70 H, HK1 4.00-10-2PR) is used with the combined type of the rim which is directly connected with the hub. In addition, the rear wheel hub and the final driven flange have been made into an integral component for lightness.



Fig. 84



Fig. 85

## b. Disassembly

- (1) The disassembly of the rear wheel can be performed without removing the muffler.
- (2) Disconnect the drive chain.
- (3) Remove the brake adjusting nut and separate the brake rod from the rear brake arm.
- (4) Separate the rear brake torque link from the brake panel.
- (5) Remove the rear wheel axle by removing the axle nut and the rear wheel can be removed with the driven sprocket. (Fig. 84)
- (6) Remove the snap ring with snap ring pliers to separate the driven sprocket from the hub. (Fig. 85)

c. Inspection

- (1) The brake drum inside diameter and the brake shoe outside diameter should be checked to the same standard.
- (2) Check the brake lining for wear in thickness. Standard value; 3.5 mm (0.1378 in) Serviceable limit; Replace if under 1.5 mm (0.0590 in) (Fig. 86).



Fig. 86

- (3) Check the rear axle diameter for wear and bend in the same manner as the front axle shaft. (Fig. 86)

mm (inch)		
	Standard Value	Serviceable Limit
Axle Diameter	11.957~11.984 (0.4704~0.4720)	—
Bend	0.2 (0.008)	Repair or replace if over 0.5 (0.02)

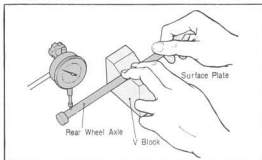

Fig. 87

- (4) Wash and clean all ball bearings. Check the bearing for wear and roughness by rotating them. Replace any defective bearings if required. Use Bearing Dr. Attach. (Tool No. 07945-0980000) with Bearing Dr. Handle (Tool No. 07949-3000000) to install.
- (5) Check the brake shoe spring for loss of tension, the oil seal for damaged or deformed lips, and the O ring for damage and loss of tension. Replace defective parts. Inflate the tire and for air leaks. Check the tire casing for imbedded nails, wires and other foreign objects. Use one or two spreaders to assist in the internal surface inspection of the tire. (Fig. 88)

d. Reassembly

- (1) Install the tire and tube in the same manner as the front wheel.
- (2) Reassemble the rear wheel to the frame and fix in place with the axle and the axle nut.
- (4) Reinstall the rear brake rod and adjust the play with the adjusting nut. Standard play of brake lever  
2~3 cm (0.787~1.181 in)
- (5) Inflate the tire to the specified air pressure. Normal condition:  
Rear:  
ST 50, 70, CT 70, CT 70H  
1.3~1.5 kg/cm (18.5~21.3 Psi)  
1.4 kg/cm (20 Psi) CT 70K1, K2, K3

Use Open End Wrench or Spreader



Fig. 88

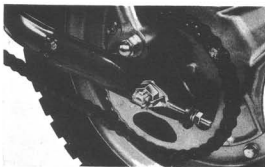

Fig. 89

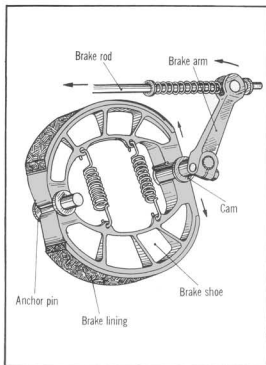

Fig. 90

#### 4.7 Braking System

Reliability and durability of the braking system is an essential requirement for safe riding.

The braking system which is adopted is an outward expanding type having a 110 mm (4.340 in) diameter. The wheel hub is light weight alloy casting which excels in heat dissipating characteristic and the brake lining contact surface is a cast iron ring.

In operation, the action of the brake lever or the foot pedal forces the cam to rotate, and this in turn forces the brake shoes, with the anchor pin as the pivot, to move outward and come in contact with the brake drum. The brake shoe is forced against the brake drum, and the friction between the brake drum and brake shoe stops the rotating wheel. With the lever released, the brake shoes return to their original position by means of two springs which hold the shoes inward. (Fig. 90)



Fig. 91

##### a. Disassembly

- (1) Remove the exhaust pipe and the muffler.
- (2) Remove the brake rod from the brake arm by loosening the brake adjusting nut, then hook off the brake pedal spring and stop switch spring (Fig. 91).
- (3) Remove the drive chain cover.
- (4) Disconnect the rear brake cable from the rear brake arm.

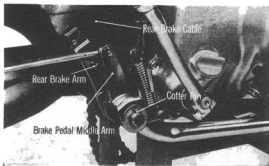

Fig. 92

- (5) Pull out the cotter pin.
- (6) Extract the brake pedal middle arm brake pedal and rear brake arm with a washer from the brake pivot pipe. (Fig. 92).

- (7) Remove the step bar from the crankcase by removing the 8 mm hex. bolts (Fig. 93).

**b. Inspection**

- (1) Inspect the brake pedal spring for loss of tension and corrosion. If loss of tension or corrosion is excessive, the spring should be replaced.
- (2) Check the brake pivot pipe for bending. If excessively bent, repair it by hitting with a hammer.
- (3) Check the cotter pin for damage.
- (4) Adjust the brake pedal play to 2~3 cm (0.787~1.181 in)
- (5) Check the brake pedal and step bar for deformities and repair or replace with new parts if necessary.

**c. Reassembly**

- (1) Clean all parts and lubricate the brake pedal pivot pipe with grease before re-assembly. Reinstall the rear brake arm, brake pedal middle arm and brake pedal to the pivot pipe.
- (2) Hook the brake pedal spring and stop switch spring on the specified positions. Connect the rear brake cable to the rear brake arm.
- (3) Reinstall the step bar on the crankcase with four 8 mm hex bolts (Fig. 94)
- (4) Reinstall the muffler.
- (5) After connecting the rear brake, adjust the brake pedal play to 2~3 cm (0.787~1.181 in).

## 4.8 Rear Fork

The rear fork is a swing arm type which pivots on the rear fork pivot bolt. The rear end of the fork is supported by the frame through the rear cushions.

**a. Disassembly**

- (1) Remove the rear wheel (see page 42).
- (2) Disconnect the drive chain.
- (3) Remove the 10 mm cap nuts fixing the rear cushion at the lower end.
- (4) Remove the rear fork pivot bolt by loosening the rear fork pivot nut, and the rear fork can then be removed from the frame. (Fig. 95)

**b. Inspection**

- (1) Check the pivot rubber bushing for damage or wear and the fork for looseness. Replace defective bushing if required. (Fig. 96).

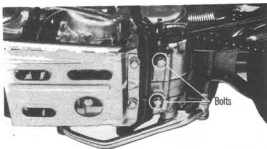

Fig. 93

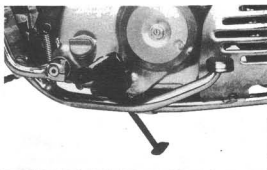

Fig. 94

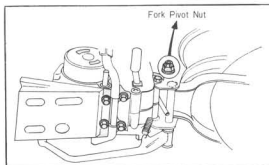

Fig. 95



Fig. 96

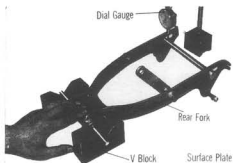

Fig. 97

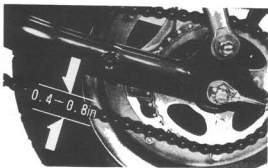

Fig. 98



Fig. 99

- (2) Check the rear fork for twisting and deformation. If twist exceeds 1 mm (0.040 in), or the part is defective, replace with a new part. (Fig. 97).
- (3) After reassembly, check L and R chain tension adjuster. They should both be set to the same alignment marks. Improper adjustment will affect the steerability. (Fig. 99).

#### c. Reassembly

The rear fork reassembly will be performed in the reverse order of disassembly.

### 4.9 Drive Chain

- (1) The drive chain should be connected so that the closed end of the link clip should point toward the direction of the normal chain rotation.
- (2) Inspect the drive chain for wear and damage. (Fig. 98)

- (3) When the drive chain has been removed or adjusted, the location of the alignment punch mark on the adjuster in respect to the marking on the rear fork must be the on the both sides.

The chain slack should be adjusted to 1~2 cm (0.040~0.080 in).

The chain must be replaced if can not be adjusted by the adjuster because it is excessively loose.

### 4.10 Air Cleaner

A clogged air cleaner will adversely affect engine performance, therefore it should be cleaned periodically as follows.

1. Unscrew the air cleaner cover setting nut and remove the air cleaner cover.
2. Remove the air cleaner element ②.
3. Wash the air cleaner element with gasoline and dry it thoroughly.
4. Soak the air cleaner element in engine oil, and squeeze by hand. Reinstall into the air cleaner case.



Fig. 100

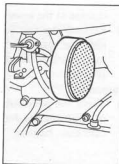

Fig. 101



## 5. ELECTRICAL SYSTEM

### Charging test

- (1) Measure the specific gravity of battery electrolyte. If it is below 1.26 (as corrected to 20°C or 68°F), recharge the battery so that the specific gravity is 1.26—1.28 (as corrected to 20°C or 68°F). Conduct the charging test in the following manner. To charge battery, see page 47.
- (2) Connect the ammeter and voltmeter to the battery as shown in Fig. 102.
- (3) Start the engine. Simulate the NIGHT-TIME RIDING and DAYTIME RIDING conditions and compare the ammeter and voltmeter readings with the specifications at the bottom of this page.

#### NOTE:

When performing the charging test raise the engine speed slowly not exceeding specified values. The ammeter and volt meter may be damaged.

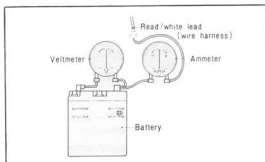

Fig. 102

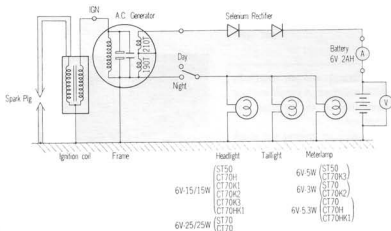

Fig. 103

### 5.1 A. C. Generator

- (1) Direction of rotation  
Left hand rotation when viewed from the installation position.
- (2) Charging performance  
Selenium rectifier (half-wave rectification), 6 V, 2 AH battery used. (Terminal voltage 6.5 V)  
Charge starting at 1000 R.P.M. at day time.  
Charge starting at 1000 R.P.M. at night.
- (3) Night operating load  
Ignition coil + 15 W + 3 W + 1.5 W  
Charging rate : 0.4 ± 0.2 A at 4000 rpm  
0.7 ± 0.3 A at 8000 rpm
- (4) Day operating load  
Ignition  
Charging rate : 1.5 ± 0.3 A at 4000 rpm  
2.4 ± 0.3 A at 8000 rpm

Item	Specification
Sparking performances (assembled coil)	Over 6 mm with 3 needle spark gap, at 3000 rpm Over 8 mm with 3 needle sparkgap, at 8000 rpm~11,000 rpm
Lighting performance	With 15 W+3 W+1, 5 W load connected over 5, 2 V at 2, 500 rpm below 9, 0 V at 8000 rpm
Charging performance	
Day operation	Charge starting at below 1,000 rpm at day time
Night operation	Charge starting at below 1,000 rpm at night
Breaker	Contact pressure 750±100 g, point gap 0, 35±0, 05 mm (0, 020±0, 0020 in)
Governor	Advance 25° (constant)

### 5-1 A.C. generator inspection

When the resistance measurement across the flywheel A.C. generator primary coil is approximately  $1.3\Omega$  the cause may be a short or grounding. An infinite resistance indicates an open circuit.

#### Caution:

Resistance measurement of the primary coil must be made with the breaker points opened and the condenser lead wire disconnected. A leaking condenser will give an improper indication.

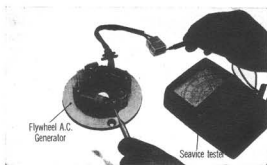

Fig. 104

### 5-2 Ignition coil

The flywheel A.C. generator and an externally mounted ignition coil is equipped. A simple method of determining serviceability of the ignition coil is by the following method;

- (1) The simplest method is to remove the spark plug and perform the starting procedure with the spark plug grounded to the engine. When a strong spark of bluish white color is produced, it is an indication of a satisfactory ignition coil and flywheel A.C. generator (Fig. 105)

If no spark or a weak spark is produced, it is an indication of defective primary coil of either the ignition coil or flywheel A.C. generator. Another reason may be that a spark is not produced across the electrodes because of a shortage or a broken wire in the primary coil

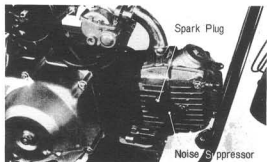

Fig. 105

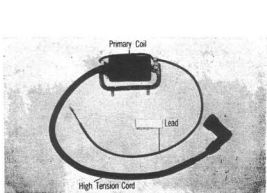

Fig. 106

- (2) Another method is to measure the resistance of the ignition coil and the flywheel A.C. generator primary coil. (Fig. 107)

Primary coil: Resistance between primary black leads and case should be approximately  $2.3 \sim 2.1 \Omega$ .

Secondary coil: Resistance between high tension lead and ground should be approximately  $9 \sim 11 \Omega$ .

**Inspection with a service tester (Tool No. 07308-0010000)**

#### 1. Ignition coil

This test is conducted to check the coil performance. If the engine fails to start, check the spark plug, points and condenser for condition.

- (1) Connect as shown in Fig. 108.
- (2) Turn the service tester coil test switch to COIL TEST.
- (3) Observing the spark jumping across a 3-point spark gap, turn the check dial and measure the jumping distance. If the spark jumps more than 6 mm (0.236 in.) in air, the coil is in good condition.

**NOTE:**

If the spark appears in the form B in Fig. 109, connect the high tension cable to the tester in the reverse direction and measure the jumping distance with the spark in the form A.

#### 5-3 Condenser inspection

- (1) Connect as shown in Fig. 110.
- (2) Turn the switch "II" to "CAPACITY" (condenser capacity measurement).
- (3) Push the "CAPACITY" button and read the scale on the tester. Specification:  $0.27 \sim 0.33 \mu F$ .



Fig. 107

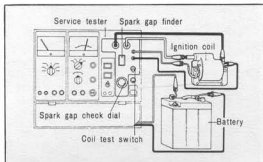

Fig. 108

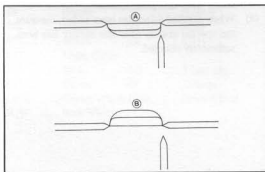

Fig. 109

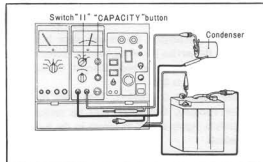

Fig. 110

### 5-4 Silicon rectifier

Using a radio tester, check for continuity. (Fig. 111)

If there is continuity in condition (A) and no continuity in condition (B), the rectifier is in good condition.

**NOTE:**

Use the radio tester with the knob in the SI range of scale.

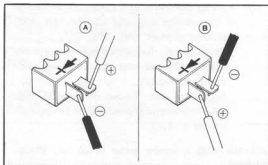

Fig. 111

### 5-5 Battery

**Inspection and servicing**

- (1) Check the battery electrolyte level.
- (2) Measure the specific gravity of battery electrolyte with a hydrometer. Place a glass cylinder vertically and suck the electrolyte slowly. When the electrolyte level rises to the eye level as shown, read the scale on the hydrometer. (Fig. 112) If the specific gravity is 1,200 (as corrected 20°C or 68°F), recharge the battery.
- (3) If the electrolyte level drops excessively, check the charging system.
- (4) When distilled water has been added, measure the specific gravity after the battery has been sufficiently charged.

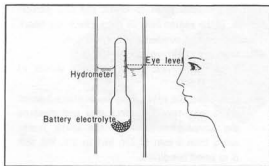

Fig. 112

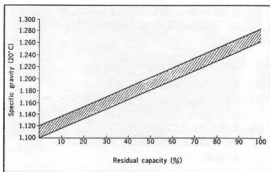

Fig. 113

**Charging**

Connect as shown in Fig. 114 and charge the battery.

**NOTES:**

- Avoid boost-charging the battery since it may shorten the service life of the battery excessively. If the battery must be boost-charged, the maximum charging is 2.0A.
- When charging the battery, keep open flames
- After charging, thoroughly wipe up spilled electrolyte. Apply a coat of grease to the battery terminals.
- When charging the batteries, connect them in series. The total available voltage can be computed by multiplying the unit voltage by the number of batteries.

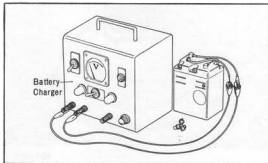

Fig. 114

	Charging	Boost charging
Charging current	0.6 A	2.0 A, max.
Completion of charging	Charge until SG value is 1.260-1.280 (as corrected to 20°C or 68°F). Air bubbles will be noted in electrolyte at end of charging.	SG value will be up to 1.260-1.280 (as corrected to 20°C or 68°F) and will be constant thereafter. Upon noting air bubbles are noted in electrolyte, reduce charging current to about 0.6 A.
Charging hours	12-13 on a battery having 1.220 SG or less (as corrected to 20°C or 68°F)	1-2 on a battery having 1.220 SG or less (as corrected to 20°C or 68°F)
Remarks	Keep away fire. Wash and lubricate terminals.	The maximum charging current must not exceed 2.0 A; otherwise it may damage cell plates.

## 5-6 Switches

### Combination switch (Main switch)

Check the combination switch for continuity at each key position (ON, OFF). If there is continuity in ○-○ in the table below, the switch is in good condition. If there is no continuity or if there is continuity between other points than in ○-○, the switch is defective. (Fig. 115-1)

MAIN SWITCH ARRANGEMENT							
TERMINAL	POSITION	E	IG	BAT1	BAT2	TL	HL
	OFF	○—○					
	I (DAY TIME)			○—○			
	II (NIGHT TIME)			○—○	○—○		○—○
WIRE COLOR		G/W	BK	R/W	R	Br	Br/R

CT78K1, K2, K3, CT78H, HK1

TERMINAL	POSITION	HL	G2	IG	E	BAT-	BAT+	TL
	OFF			○—○	—			
	I (DAY TIME)			○—○	○—○			
	II (NIGHT TIME)	○—○		○—○	○—○		○—○	
WIRE COLOR		Br/R	Y	BK		BL	R	BR

(ST50, England type)

TERMINAL	POSITION	IG	E	BAT	HO
	OFF	○—○			
	I (DAY TIME)			○—○	
WIRE COLOR		BK	G/W	R/W	R

(ST78 England type)

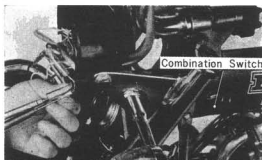

Fig. 115

Br	.....Brown	Y	.....Yellow
BK	.....Black	Bl	.....Blue
W	.....White	Gr	.....Gray
LG	.....Light Green		
R	.....Red	LB	.....Light Blue
G	.....Green	O	.....Orange
G/W	.....Green/White	Br/R	.....Brown/Red
R/W	.....Red/White		

**Rear stop switch**

Turn on the combination switch, depress the brake pedal and check if the stop light comes on or if the bulb is burnt out.

Remove the stop switch spring. Attach the probes of a tester to the switch leads (black and green/yellow) and check for continuity.

The stop light should come on when the brake pedal is depressed and moved 20 mm (0.7874 in.) as measured at the tip of the pedal.

To adjust the switch timing, turn the adjusting nut.



Fig. 116

**Horn as horn button switch****(1) Horn**

Connect the horn to a fully charged 6V battery and check if the horn sounds properly.

If the horn fails to sound properly, adjust it by turning the adjusting screw located to the rear side of horn in either direction. (Fig. 117)

**(2) Horn button**

Push the horn button and check if the horn sounds. If not, check the horn button for condition.

Attach the probes of a tester to the terminal of the light green lead located inside the headlight case and to the handlebar pipe. Push the horn button and check for continuity. If there is continuity, the horn button is in good condition.



Fig. 117

**Turn signal switch**

With the combination switch turned on, operate the turn signal switch. If the bulbs fail to flash, check them for condition. If they are not burnt out, check the turn signal switch for condition. Disconnect the turn signal switch leads from inside the headlight case. Then check for continuity between the gray lead and light blue lead (right side) and the gray lead and orange lead (left side). If there is continuity, the switch is in good condition.

Knob position	Lead color		
	Light blue	Gray	Orange
R	○ — ○		
OFF			
L		○ — ○	

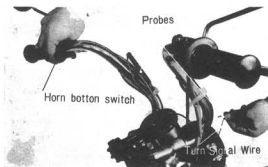

Fig. 118

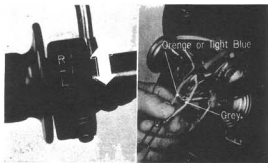

Fig. 119

### Headlight control switch

Using a tester, check each lead for open circuit or improper connection. If there is continuity in  $\bigcirc-\bigcirc$  in the table below, the switches are in good condition. If there is no continuity, the switches are defective. If there is a continuity between other points than in  $\bigcirc-\bigcirc$ , the switches are defective.

Lead color \ Knob position	White	Brown/red	Blue
H	$\bigcirc-\bigcirc$		
L		$\bigcirc-\bigcirc$	

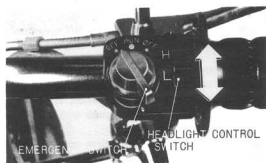

Fig. 120

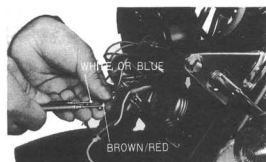

Fig. 121

### Neutral switch

Place the transmission in neutral and check for continuity between the switch and engine using a service tester. If there is continuity at the neutral position only, the switch is in good condition.



Fig. 122

### Emergency switch Construction

The emergency ignition switch (kill button) is provided to shut off the engine when the motorcycle is overturned or when trouble develops in the throttle system. (Fig. 123)

#### Disassembly

Loosen switch mounting screws and separate the halves.

Disconnect the wirings within the headlight case and remove the switch assembly.

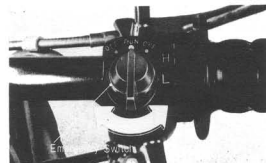

Fig. 123.

**Inspection**

Start the engine. Check the operation of the emergency switch. If the respective switch positions are not functioning properly, the switch or wiring is defective.

If the wiring is correct, check the testing conductivity of wires with the switch. If the conductivity is not correct, replace with new one. Reassembly

Perform assembly in the reverse order of disassembly. Check switch operation.

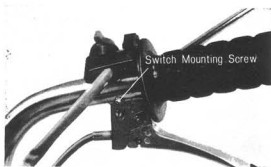

Fig. 124

**Operation**

The operational principle of the emergency ignition switch is shown in Fig. 125. Even if ignition switch is ON, the primary circuit can be opened by operating the switch. (Fig. 125)

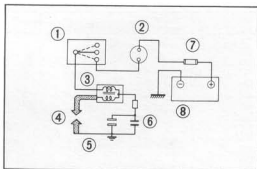
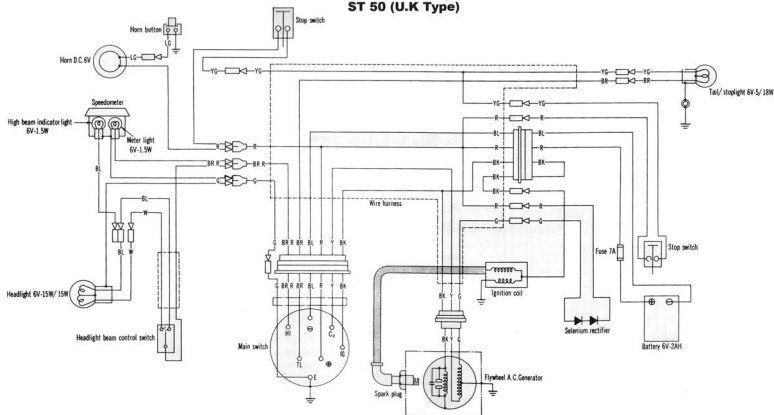

Fig. 125 **Emergency switch operation**  
 ① Emergency switch ② Main switch ③ Ignition coil  
 ④ Spark plug ⑤ Contact breaker ⑥ Con- denser ⑦ Fuse 15A ⑧ Battery 6V-6AH



### ST 50 (U.K Type)

### 6. WIRING DIAGRAM



MAIN SWITCH SWITCHING ARRANGEMENT					
OFF			⊖	⊕	
I			⊖	⊕	
II			⊖	⊕	
	BR.R	Y	BK	BL	R

- BK ..... Black
- BL ..... Blue
- BR ..... Brown
- G ..... Green
- LG ..... Light green
- R ..... Red
- W ..... White
- Y ..... Yellow
- YG ..... Yellowish green
- BR.R ..... Brown with red Spiral



### ST 70-II (General Export Type)

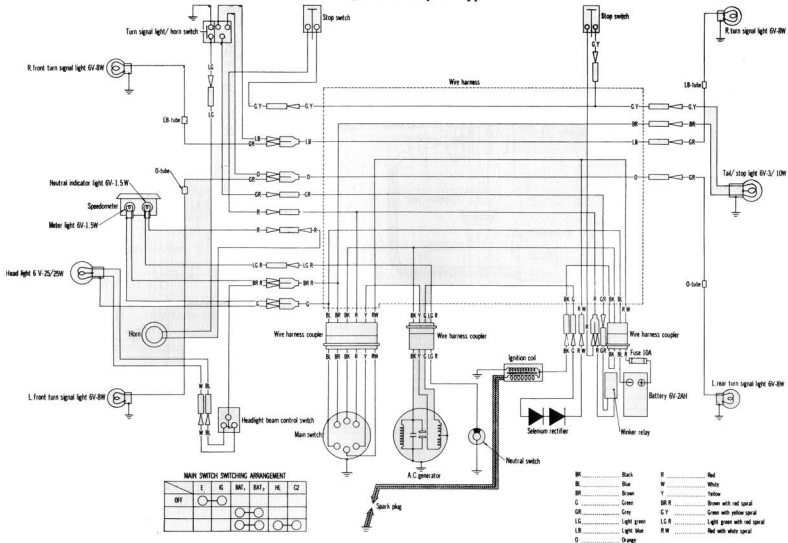

### CT 70 (U. S. A. Type)

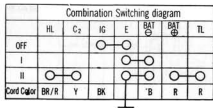
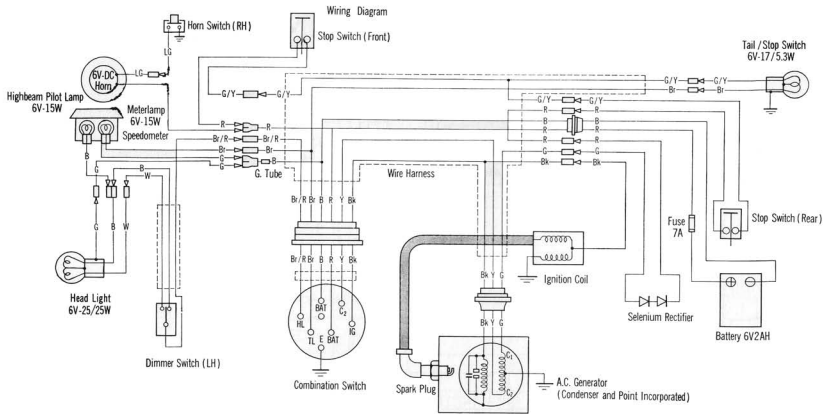

W	..... White	LB	..... Light Blue
B	..... Blue	LG	..... Light Green
O	..... Orange	Y/R	..... Yellow / Red
Y	..... Yellow	LG/R	..... Light Green / Red
GR	..... Grey	B/R	..... Blue / Red
BK	..... Black	Bk/W	..... Black / White
G	..... Green	Br/W	..... Brown / White
R	..... Red	Y. Tube	..... Yellow Tube
BK	..... Brown	LG. Tube	..... Light Green Tube
P	..... Pink	R. Tube	..... Red Tube
HCS	..... Headlight Control Switch		

### CT 70H (U. S. A. Type)

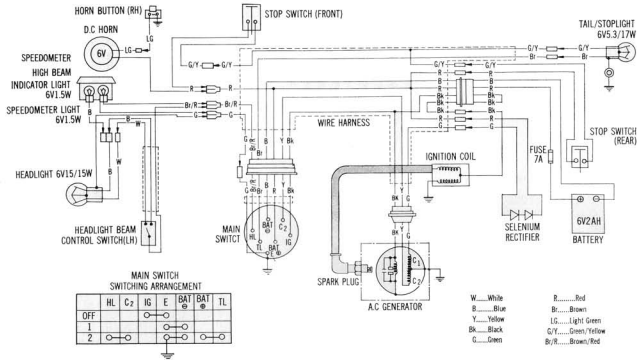

## 7. INDEX

- A -
  - Air Cleaner .....46
  - A. C Generator.....46
- B -
  - Braking System.....39
    - Disassembly .....40
    - Inspection .....40
    - Reassembly.....41
  - Brake Drum .....40
  - Brake Lining.....40
- C -
  - Cam Chain Tensioner.....21
  - Carburetor.....31
  - Clutch.....23
  - Camshaft .....19
  - Check Valve .....21
  - Crankshaft .....25
- D -
  - Drive Chain.....13, 46
- E -
  - Engine.....12
  - Engine Removal and Installation.....12
- F -
  - Foreword ..... 1
  - Frame.....34
  - Front Fork.....35
    - Disassembly .....35
    - Inspection .....35
    - Reassembly .....36
  - Front axle .....41
  - Front Wheel .....39
    - Construction .....40
    - Disassembly .....40
  - Front Cushion .....36
    - Construction .....36
    - Disassembly .....36
    - Inspection .....38
    - Reassembly .....40
  - Front Hub.....40
    - Inspection .....40
    - Reassembly .....41
- K -
  - Kick Starter .....30
- L -
  - Lubrication .....14
- M -
  - Muffler .....12
- O -
  - Oil Pump .....14
- P -
  - Piston .....21
  - Piston Rings .....21
- R -
  - Rear Axle .....43
  - Rear Cushion .....38
    - Construction .....38
    - Disassembly .....39
    - Inspection .....39
    - Reassembly .....39
  - Rear Fork .....45
    - Construction .....45
    - Disassembly .....45
    - Inspection .....45
    - Reassembly .....46
  - Rear Wheel .....42
    - Construction .....42
    - Disassembly .....42
    - Inspection .....43
    - Reassembly .....43
- S -
  - Specifications ..... 3
  - Special Tools.....10
  - Spark Plugs .....12
- T -
  - Tightening Torque Limits .....33
  - Tire Pressure.....41
  - Throttle Wire .....12
  - Transmission .....27
  - Timing .....19
- V -
  - Valve.....17, 18
    - Seat .....17
- W -
  - Wiring Diagram .....55

## 10 CT70K4 ADDENDUM

### 1. Fuel valve

The indication marks and a positions on the fuel cock were changed to a new type.

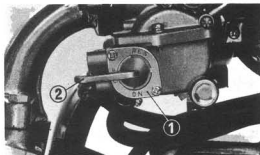

Fig. K4-1 ① Fuel valve ② Lever

### 2. Switches

The dimmer switch, located on the switch housing at the right side of the steering handlebar, was moved to the left switch housing. This also necessitated changes in the design of the switch housings. The throttle grip was changed to a new, wind-in type.

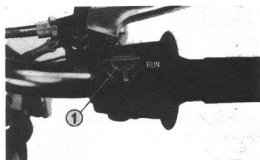

Fig. K4-2 ① Engine stop switch

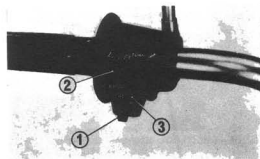

Fig. K4-3 ① Dimmer switch ② Turn signal control switch ③ Horn switch

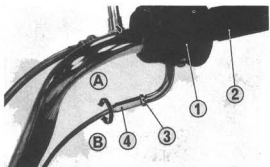

Fig. K4-4 ① Switch case ② Throttle grip ③ Lock nut ④ Upper adjuster



Fig. K4-5 ① Throttle cable

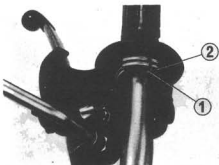

Fig. K4-6 ① Throttle cable end ② Grip pipe



Fig. K4-7 ① Rear shock absorber

### 3. Throttle grip

The throttle grip was changed to a new, wind-in type.

#### Inspection and adjustment

1. Check the free play of the throttle grip. It should be 10–15° of the grip rotation.
2. To adjust, loosen the lock nut and turn the upper adjuster in or out as necessary. Rotation of the adjuster in direction (A) decreases the play, and rotating in direction (B) increases the play.  
Tighten the lock nut after adjustment.

3. Check the throttle cable for twisting or interference with adjacent parts; also for proper routing, while turning the handlebar to each extreme.

Repair or, if necessary, replace the cable with a new one.

#### Disassembly and assembly

1. Loosen the screws securing the switch housing to the handlebar. Separate the housing.
2. Disconnect the throttle cable end from the throttle grip pipe.
3. Withdraw the throttle grip from the handlebar.
4. Assemble the throttle grip in the reverse order or disassembly.

### 4. Rear shock absorber

The rear shock absorber upper case, was discontinued.



## 5. Side stand

The side stand was changed to a new type with a shock absorbing rubber pad.

The stand must be inspected periodically to determine that it is in good condition.

### Inspection

1. Check the entire stand assembly (side stand bar, bracket and rubber) for installation, deformation or excessive damage.
2. Check the spring for damage or other defects.

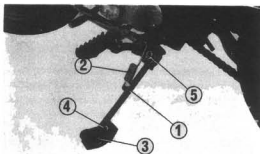

Fig. K4-8 ① Side stand bar ② Side stand spring  
③ Rubber pad ④ 6 mm bolt ⑤ Side stand pivot bolt

3. Check the side stand for proper return operation:

- a. With the stand applied, tilt the machine so that it clears the ground.
- b. Attach a spring scale to the lower end of the stand and measure the force with which the stand is returned to its original position.
- c. The stand condition is correct if the measurement falls within 2-3 kg (4.4-6.6 lbs.)

If the stand requires force exceeding the above limit, this may be due to neglected lubrication, overtightened side stand pivot bolt, worn stand bar or bracket, or excessive tension. Repair as necessary.

4. Check the rubber pad for deterioration or wear.

When the rubber pad wear is so excessive that it is worn to the wear line, replace it with a new one.

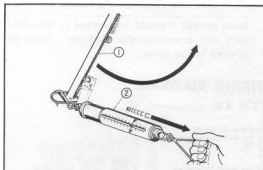

Fig. K4-9 ① Side stand bar ② Spring scale

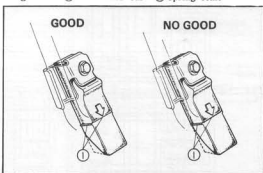

Fig. K4-10 ① Wear line

### Rubber replacement

1. Remove the 6 mm bolt. Separate the rubber from the bracket at the side stand.
2. After installing the collar place a new rubber pad in the bracket with the arrow mark facing out.

#### NOTE:

Use a rubber pad with the mark "BELOW 259 lbs ONLY".

3. Secure the rubber pad with the 6 mm bolt.

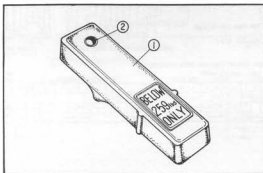

Fig. K4-11 ① Rubber pad ② Collar

## 6. Maintenance schedule

Additions in the MAINTENANCE SCHEDULE, are shown below:

MAINTENANCE SCHEDULE		REGULAR SERVICE PERIOD			
This maintenance schedule is based on average riding conditions. Machines subjected to severe use, or ridden in unusually dusty areas, require more frequent servicing.		INITIAL SERVICE PERIOD	Perform at every indicated month or mileage interval, whichever occurs first.		
800 km	1 month	1 month	3 months	6 months	12 months
	800 km	2,500 km	5,000 km	1,000 km	
500 miles	500 miles	1,500 miles	3,000 miles	6,000 miles	
* SIDE STAND—Check installation, operation, deformation, damage and wear.				○	

Items marked \* should be serviced by an authorized Honda dealer, unless the owner has proper tools and is mechanically proficient. Other maintenance items are simple to perform and may be serviced by the owner.

## 7. WIRING DIAGRAM

(CT 70 K 4)

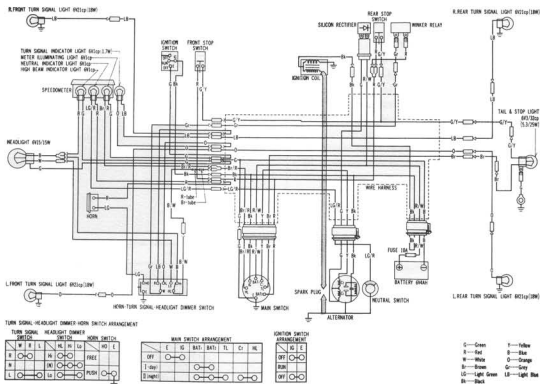

## Frame No. CT70-2600008 and subsequent

### 1. GENERATOR

Charging characteristics

Initial charging rpm	Less than 1,500 rpm
4,000 rpm	1.4 ± 0.3A
8,000 rpm	2.2 ± 0.4A

### 2. WIRING DIAGRAM

(CT70 '77)

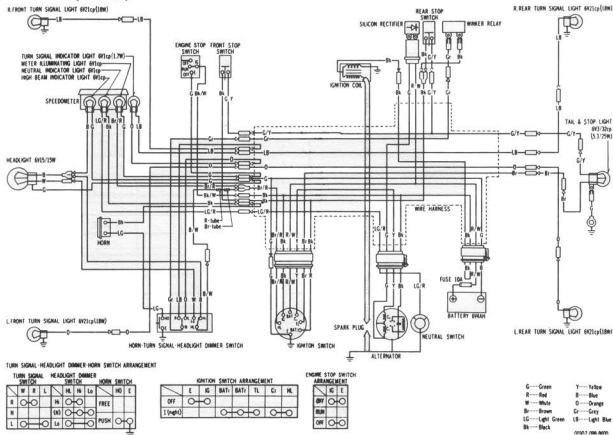

## 3. MAINTENANCE SCHEDULE

MAINTENANCE SCHEDULE	INITIAL SERVICE PERIOD	REGULAR SERVICE PERIOD Perform at every indicated month or mileage interval, whichever occurs first.			
	Month	1	3	6	12
	Mile	500	1,500	3,000	6,000
	Km	1,000	2,500	5,000	10,000
ENGINE OIL	R		R		
*CENTRIFUGAL OIL FILTER					C
*OIL FILTER SCREEN					C
SPARK PLUG				I	
*CONTACT BREAKER POINTS	I			I	
*IGNITION TIMING	I			I	
*VALVE TAPPET CLEARANCE	I			I	
*CAM CHAIN TENSION	I			I	
POLYURETHANE FOAM AIR FILTER ELEMENT		service more frequently if operated in dusty areas		C	
*CARBURETOR	I			I	
THROTTLE OPERATION	I			I	
FUEL FILTER SCREEN				C	
FUEL LINES				I	
*CLUTCH	I			I	
DRIVE CHAIN	**I & L	I & L			
SPARK ARRESTOR			C		
*BRAKE SHOES				I	
BRAKE CONTROL LINKAGE	I			I	
WHEEL RIMS	I			I	
TIRES	I	I			
FRONT FORK OIL	***R				
FRONT AND REAR SUSPENSION	I			I	
REAR FORK BUSHING				I & L	
*STEERING HEAD BEARINGS					I
*SIDE STAND				I	
BATTERY	I		I		
LIGHTING EQUIPMENT	I	I			
NUTS, BOLTS (TIGHTEN)					

I-Inspect, clean, adjust or replace if necessary R-Replace C-Clean L-Lubricate

Items marked \* should be serviced by an authorized HONDA dealer, unless the owner has proper tools and is mechanically proficient. Other maintenance items may be serviced by the owner. \*\* Initial service period 200 miles. \*\*\* Initial service period 1,500 miles.

## 4. SPECIFICATIONS

Item		
<b>DIMENSION</b>		
Overall Length		1,515 mm (59.6 in.)
Overall Width		670 mm (26.4 in.)
Overall Height		1,020 mm (40.2 in.)
Wheel Base		1,050 mm (41.3 in.)
Seat Height		740 mm (29.1 in.)
Ground Clearance		165 mm ( 6.5 in.)
Dry Weight		72 kg (158.4 lb.)
<b>FRAME</b>		
Type		Back bone
F. Suspension, Travel		Telescopic fork, travel 50 mm (1.96 in.)
R. Suspension, Travel		Swing arm, travel 64 mm (2.52 in.)
F. Tire Size, Type		4.00-10-2 PR Knobby, tire air pressure 1.25 kg/cm <sup>2</sup> , (18 psi.)
R. Tire Size, Type		4.00-10-2 PR Knobby, tire air pressure 1.5 kg/cm <sup>2</sup> , (21 psi.)
F. Brake		Internal expanding shoe
R. Brake		Internal expanding shoe
Fuel Capacity		2.5 lit. (0.66 U.S. gal., 0.54 Imp. gal.)
Fuel Reserve Capacity		0.5 lit. (0.13 U.S. gal., 0.11 Imp. gal.)
Caster Angle		63°
Trail Length		70 mm (2.73 in.)
<b>ENGINE</b>		
Type		Air cooled 4 stroke O.H.C. engine
Cylinder Arrangement		Single cylinder 90° inclined from vertical
Bore and Stroke		47.0 x 41.4 mm (1.850 x 1.630 in.)
Displacement		72 cc (4.4 cu. in.)
Compression Ratio		8.8
Valve Train		Chain driven over head camshaft
Oil Capacity		0.8 lit. (0.8 U.S. qt., 0.7 Imp. qt.)
Lubrication System		Forced and wet sump
Intake valve	Opens	5° BTDC
	Closes	25° ABDC
Exhaust valve	Opens	20° BBDC
	Closes	5° ATDC
Valve Tappet Clearance Idle Speed		IN, EX: 0.05 mm (0.002 in.)
<b>DRIVE TRAIN</b>		
Clutch		Wet multi-plate Automatic (Centrifugal)
Transmission		3-speed constant mesh
Primary Reduction		4.058
Gear Ratio I		3.272
Gear Ratio II		1.722
Gear Ratio III		1.190
Final Reduction		2.333, drive sprocket 15T, driven sprocket 35T
Gear Shift		Left foot operated return system
<b>ELECTRICAL</b>		
Ignition		Flywheel magneto
Ignition timing "F" mark		25° BTDC
Starting System		Kick starter
Alternator		A.C. generator, 0.057 kw/8,000 rpm
Battery Capacity		6V-4AH
Spark Plug		NGK C7HS, ND U22FS (U.S.A. model) NGK CR7HS, ND U22FSR-L (Canadian model)
Condenser capacity		0.22-0.26μF

**Page intentionally blank**

Frame No. CT70-2700005 and subsequent

Manufactured before February, 1978

## 1. CARBURETOR

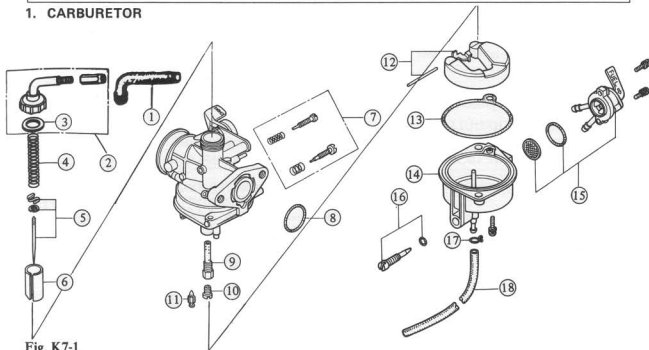



Fig. K7-1

- |                           |                       |                        |
|---------------------------|-----------------------|------------------------|
| (1) Rubber cap            | (7) Screw set         | (13) Carburetor gasket |
| (2) Carburetor top set    | (8) O-ring            | (14) Float chamber     |
| (3) Carburetor top washer | (9) Needle jet holder | (15) Valve set         |
| (4) Throttle valve spring | (10) Main jet         | (16) Drain screw       |
| (5) Jet needle set        | (11) Float valve      | (17) Tube clip         |
| (6) Throttle valve        | (12) Float set        | (18) Drain tube        |

### Carburetor Setting Table

Item	
Setting mark	PB36A
Main jet	No. 55
Jet needle setting	
Float height (gauge)	10.7mm (0.42 in.)

### Idle Speed Adjustment

1. Warm up the engine to operating temperature.
2. Turn the throttle stop screw to find the point of lowest rpm. (Approx. 1,200rpm)
3. Turn the pilot screw to find the highest rpm. Usually the correct setting is 1-3/4 turns open from a fully closed position.
4. Set the idle speed to specifications with the throttle stop screw.  
Specified idle speed: 1,300 rpm
5. Turn the pilot screw to see if the speed increases. If the speed increases, repeat the above steps.



Fig. K7-2 (1) Throttle stop screw  
(2) Pilot screw

#### NOTE:

Turning the pilot screw in produces a lean fuel/air mixture, turning the screw out produces a rich fuel/air mixture.

## 2. MAINTENANCE SCHEDULE

Perform the Pre-Ride Inspection described in the Owner's Manual at each maintenance period.

I: INSPECT, CLEAN, ADJUST, OR REPLACE IF NECESSARY. C: CLEAN R: REPLACE A: ADJUST

ITEM	FREQUENCY	WHICHEVER COMES FIRST ↓ EVERY	ODOMETER READING [NOTE(2)]			
			600 mi. (1,000km)	2,400mi. (4,000km)	4,800mi. (8,000km)	7,200mi. (12,000km)
ENGINE OIL		YEAR	R	REPLACE EVERY 1,200 mi. (2,000km)		
* ENGINE OIL FILTER ROTOR					C	
* ENGINE OIL FILTER SCREEN					C	
AIR CLEANER		NOTE (1)		C	C	C
* FUEL LINES				I	I	I
SPARK PLUG				I	I	R
* VALVE CLEARANCE			I	I	I	I
* CONTACT BREAKER POINTS			I	I	I	I
* IGNITION TIMING			I	I	I	I
* CAM CHAIN TENSION			A	A	A	A
* THROTTLE OPERATION			I	I	I	I
* CARBURETOR IDLE SPEED			I	I	I	I
* CARBURETOR CHOKE				I	I	I
DRIVE CHAIN		NOTE (3)	INSPECT EVERY 600 mi. (1,000km)			
BATTERY ELECTROLYTE		MONTH	I	I	I	I
BRAKE SHOE WEAR				I	I	I
BRAKE FREE PLAY			I	I	I	I
* BRAKE LIGHTING SWITCH			I	I	I	I
* HEADLIGHT AIM			I	I	I	I
CLUTCH FREE PLAY			I	I	I	I
SIDE STAND				I	I	I
* SUSPENSION			I	I	I	I
* SPARK ARRESTER				I	I	I
* NUTS, BOLTS, FASTENERS			I	I	I	I
** WHEELS			I	I	I	I
** STEERING HEAD BEARING			I			I

\*\* IN THE INTEREST OF SAFETY, WE RECOMMEND THESE ITEMS BE SERVICED ONLY BY AN AUTHORIZED HONDA DEALER.

\* SHOULD BE SERVICED BY AN AUTHORIZED HONDA DEALER, UNLESS THE OWNER HAS PROPER TOOLS AND SERVICE DATA AND IS MECHANICALLY QUALIFIED.

- NOTES: (1) More frequent service may be required when riding in dusty areas.  
(2) For higher odometer readings, repeat at the frequency interval established here.  
(3) Initial service period 200 miles.



## INTRODUCTION

Emission Related Maintenance Procedures are described in this Addendum. They are mandatory for CT70's manufactured after December 31, 1977.

Follow the Maintenance Schedule recommendations (page 79) to ensure that the vehicle is always in peak operating condition and the emission levels are within the standards set by the Federal Clean Air Act. (USA only). Performing the first scheduled maintenance is very important. It compensates for the initial wear that occurs during the break-in period.

ALL INFORMATION, ILLUSTRATIONS, DIRECTIONS AND SPECIFICATIONS INCLUDED IN THIS PUBLICATION ARE BASED ON THE LATEST PRODUCT INFORMATION AVAILABLE AT THE TIME OF APPROVAL FOR PRINTING. HONDA MOTOR CO., LTD. RESERVES THE RIGHT TO MAKE CHANGES AT ANY TIME WITHOUT NOTICE AND WITHOUT INCURRING ANY OBLIGATION WHATEVER.

NO PART OF THIS PUBLICATION MAY BE REPRODUCED WITHOUT WRITTEN PERMISSION.

HONDA MOTOR CO., LTD.

Service Publications Office

## CONTENTS

I.	SPECIFICATIONS .....	73
II.	EMISSION CONTROL SYSTEM .....	74
III.	MAINTENANCE SCHEDULE .....	75
IV.	WIRING DIAGRAM .....	76
V.	INSPECTION AND ADJUSTMENT	
1.	ENGINE OIL .....	77
2.	ENGINE OIL FILTER SCREEN/CENTRIFUGAL OIL FILTER .....	78
3.	CRANKCASE BREATHER (USA only) .....	78
4.	AIR CLEANER .....	79
5.	FUEL LINES .....	79
6.	SPARK PLUG .....	79
7.	VALVE CLEARANCE .....	80
8.	CONTACT BREAKER POINT GAP AND IGNITION TIMING .....	80
9.	CAM CHAIN TENSION .....	81
10.	THROTTLE OPERATION .....	82
11.	CARBURETOR IDLE SPEED .....	82
12.	CARBURETOR CHOKE .....	82
13.	DRIVE CHAIN .....	83
14.	BATTERY .....	84
15.	BRAKE SHOE WEAR .....	84
16.	BRAKE SYSTEM .....	85
17.	BRAKE LIGHT SWITCH .....	86
18.	HEADLIGHT AIM .....	87
19.	CLUTCH .....	87
20.	SIDE STAND .....	87
21.	SUSPENSION .....	88
22.	SPARK ARRESTER .....	88
23.	WHEELS .....	89
24.	STEERING HEAD BEARING .....	89
25.	NUTS, BOLTS, FASTENERS .....	89
VI.	CARBURETOR	
1.	CARBURETOR ASSEMBLY/DISASSEMBLY .....	90
2.	PILOT SCREW ADJUSTMENT .....	91
3.	HIGH ALTITUDE ADJUSTMENT .....	91
VII.	HANDLEBAR .....	92
VIII.	CRANKCASE BREATHER (USA only) .....	93
IX.	CABLE ROUTING .....	94

## I. SPECIFICATIONS

DIMENSIONS	Overall length Overall width Overall height Wheel base Seat height Foot peg height Dry weight	1,515mm (59.6 in) 670mm (26.4 in) 1,020mm (40.2 in) 1,050mm (41.3 in) 740mm (29.1 in) 290mm (11.4 in) 71kg (156.4 lb)
FRAME	Type Front suspension, travel Rear suspension, travel Front tire size, pressure Rear tire size, pressure Front brake Rear brake Fuel capacity Fuel reserve capacity Caster angle Trail length	Back bone Telescopic fork, 50mm (1.97 in) Swing arm, 64mm (2.52 in) 4.00-10-2PR, 1.25kg/cm <sup>2</sup> (18 psi) 4.00-10-2PR, 1.5kg/cm <sup>2</sup> (21 psi) Internal expanding shoe Internal expanding shoe 2.5 lit (0.66 US gal, 0.54 Imp gal) 0.5 lit (0.13 US gal, 0.11 Imp gal) 63° 70mm (2.75 in)
ENGINE	Type Cylinder arrangement Bore and stroke Displacement Compression ratio Valve train Oil capacity Lubrication system Air filtration Compression pressure Intake valve Opens Exhaust valve Opens Valve clearance Idle speed	Air cooled 4-stroke OHC engine Single cylinder 80° inclined from vertical 47.0 x 41.4mm (1.85 x 1.63 in) 72cc (4.4 cu in) 8.8 : 1 Chain driven overhead cam shaft 0.8 lit (0.8 US qt, 0.7 Imp qt) Forced and wet sump Oiled polyurethane foam 12kg/cm <sup>2</sup> (170.7 psi) 74° BTDC } 78° ABDC } at O lift 89° BBDC } 63° ATDC } IN/EX, 0.05mm (0.002 in) 1,300 ±100 rpm
DRIVE TRAIN	Clutch Transmission Primary reduction Gear ratio I II III Final reduction Gear shift pattern	Wet multi-plate automatic (Centrifugal) 3-speed constant mesh 4.058 3.272 1.722 1.190 2.333, drive sprocket 15T, driven sprocket 35T Left foot operated return system
ELECTRICAL	Ignition Ignition advance F mark Starting system Alternator Battery capacity Spark plug  Headlight Low/High Tail/stoptlight Turn signal light Speedometer light Neutral indicator light Turn signal indicator light High beam indicator light	Flywheel magneto 25° BTDC Kick starter Flywheel 57w/8,000 rpm 6V-4AH (NGK) C7HS, (ND) U22FS Canadian model (NGK) CR7HS, (ND) U22FSR-L 6V-15/15W 5.3/25W (3/32 cp) 18W (21 cp) 1.7W (1 cp) 1.7W (1 cp) 1.7W (1 cp) 1.7W (1 cp)

## II. EMISSION CONTROL SYSTEM (USA only)

CT70's manufactured after December 31, 1977 are equipped with two Emission Control Systems.

### EXHAUST EMISSION CONTROL SYSTEM

The exhaust emission control system is composed of a factory pre-set carburetor. No adjustments should be made except to the idle speed with the throttle stop screw.

### CRANKCASE EMISSION CONTROL SYSTEM

The engine is equipped with a "Closed System" to prevent crankcase emissions entering the atmosphere. Blow-by gas is returned to the combustion chamber through the breather tube, separator and intake pipe.

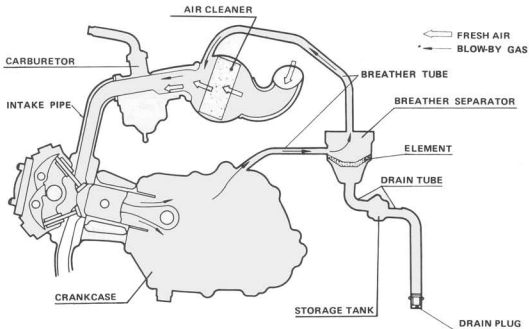

### EMISSION INFORMATION LABEL

An Emission Control Information Label is on the steering stem head. It contains basic tune-up specifications.

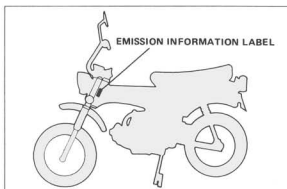

### III. MAINTENANCE SCHEDULE

Perform the PRE-RIDE INSPECTION in the Owner's Manual at every maintenance period.

- I : Inspect and Clean, Adjust, Lubricate or Replace if necessary.
- C : Clean
- R : Replace
- A : Adjust
- L : Lubricate

ITEM	FREQUENCY	WHICHEVER COMES FIRST  ↓	ODOMETER READING [NOTE (3)]				
			600mi (1,000km)	2,500mi. (4,000km)	5,000mi. (8,000km)	7,500mi. (12,000km)	Refer to Page
		EVERY					
EMISSION RELATED ITEMS	ENGINE OIL	YEAR	R	REPLACE EVERY 1,250 mi. (2,000 km)			77
	* ENGINE OIL FILTER SCREEN				C		78
	CRANKCASE BREATHER (USA only)	NOTE (1)		C	C	C	78
	AIR CLEANER	NOTE (2)		C	C	C	79
	* FUEL LINES			I	I	I	79
	SPARK PLUG			I	I	R	79
	* VALVE CLEARANCE		I	I	I	I	80
	* CONTACT BREAKER POINTS		I	I	I	I	80
	* IGNITION TIMING		I	I	I	I	80
	* CAM CHAIN TENSION		A	A	A	A	81
	* THROTTLE OPERATION		I	I	I	I	82
	* CARBURETOR CHOKE			I	I	I	82
	* CARBURETOR IDLE SPEED		I	I	I	I	82
	DRIVE CHAIN		I L EVERY 300 mi. (500 km)				83
	NON-EMISSION RELATED ITEMS	BATTERY	MONTH	I	I	I	I
BRAKE SHOE WEAR				I	I	I	84
BRAKE SYSTEM			I	I	I	I	85
* BRAKE LIGHT SWITCH			I	I	I	I	86
* HEADLIGHT AIM			I	I	I	I	87
CLUTCH			I	I	I	I	87
SIDE STAND				I	I	I	87
* SUSPENSION			I	I	I	I	87
* SPARK ARRESTER				C	C	C	88
* NUTS, BOLTS, FASTENERS			I	I	I	I	89
** WHEELS			I	I	I	I	88
** STEERING HEAD BEARING			I			I	89

- \* SHOULD BE SERVICED BY AN AUTHORIZED HONDA DEALER, UNLESS THE OWNER HAS PROPER TOOLS AND SERVICE DATA AND IS MECHANICALLY QUALIFIED.
- \*\* IN THE INTEREST OF SAFETY, WE RECOMMEND THESE ITEMS BE SERVICED ONLY BY AN AUTHORIZED HONDA DEALER.

NOTES: (1) More frequent service may be required when riding in rain or at full throttle.  
 (2) More frequent service may be required when riding in dusty areas.  
 (3) For higher odometer readings, repeat at the frequency interval established here.

## IV. WIRING DIAGRAM

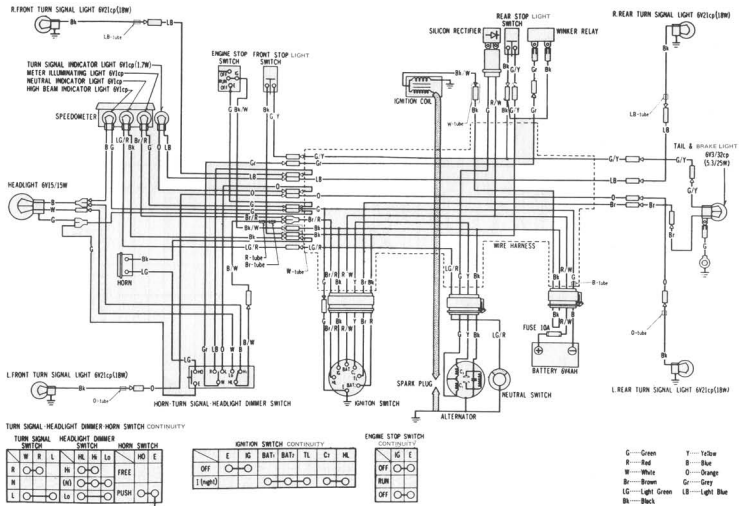

## V. INSPECTION AND ADJUSTMENT

### 1. ENGINE OIL

#### ENGINE OIL LEVEL CHECK

1. Start the engine and operate until warm. Stop the engine.
2. Support the motorcycle upright on level ground.
3. Check the oil level with the filler cap/dipstick.
4. Do not screw in the cap when making this check.

#### NOTE

If the level is below the lower level mark on the dipstick, fill to the upper level mark with the recommended oil.

#### ENGINE OIL CHANGE

#### NOTE

Drain the oil while the engine is warm and the motorcycle upright.

1. Remove the oil filler cap and drain plug and drain the oil.
2. Install the drain plug, making sure the sealing washer is in good condition.

TORQUE: 2.0–3.0 kg-m (15–22 ft-lb)

3. Fill the crankcase with the recommended oil.

#### ENGINE OIL CAPACITY:

0.8ℓ (0.8 US qt 0.7 Imp qt) at draining

#### RECOMMENDED OIL:

HONDA 4-STROKE OIL or equivalent.

API Service Classification: SE

Viscosity:

General, all temperatures: SAE 10W-40

Alternate:

Above 15°/60°F	SAE 30
-10° to 15°C (15–60°F)	SAE 20 or SAE 20W
Below 0°/32°F	SAE 10W
Above-10°C (15°F)	SAE 20W-50

4. Reinstall the oil filler cap.
5. Start the engine and allow it to idle for 2–3 minutes.
6. Stop the engine, make sure that the oil level is at the upper level mark with the motorcycle upright. Check for oil leaks.

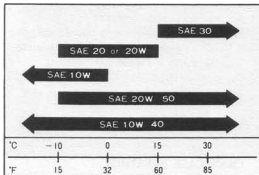
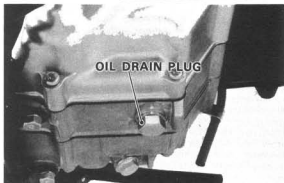
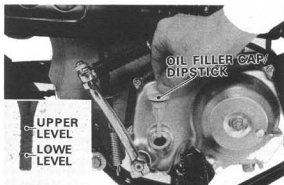

## 2. ENGINE OIL FILTER SCREEN/CENTRIFUGAL OIL FILTER

### NOTE

Clean the engine oil filter screen before filling the crankcase with oil.

1. Warm up the engine for 2–3 minutes.
2. Stop the engine, remove the oil filler cap and drain plug and drain the oil.
3. Remove the kick starter pedal and foot peg assembly.
4. Remove the right crankcase cover.
5. Remove the oil filter screen and clean it.
6. Remove the clutch outer cover.
7. Clean the clutch outer cover and the clutch outer using a clean lint free cloth.
8. Reinstall the screen clutchouter cover and right crankcase cover.
9. Install the drain plug, making sure the sealing washer is in good condition.
10. Reinstall the foot peg assembly.
11. Reinstall the kick starter pedal.
12. Fill the crankcase with the recommended engine oil.
13. Start the engine and let it idle for 2–3 minutes.
14. Stop the engine and recheck the oil level.
15. Check for oil leaks.

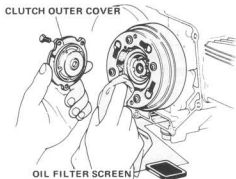

## 3. CRANKCASE BREATHER

1. Remove the drain plug from the drain tube and drain deposits.
2. Reinstall the drain plug.

### NOTE

Service more frequently when riding in rain, or at wide throttle openings or if deposits can be seen in the storage tank.

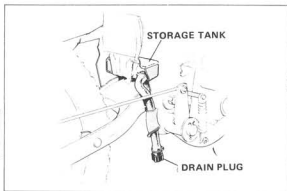



#### 4. AIR CLEANER

1. Remove the air cleaner cover.
2. Remove the air cleaner element and holder.

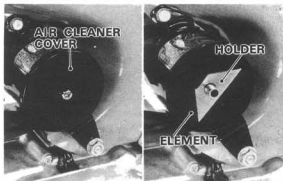

3. Wash the element in non-flammable or high flash point solvent and allow to dry.
4. Soak the element in gear oil (#80-#90), then squeeze out excess oil.
5. Reinstall the element with the holder.
6. Reinstall the air cleaner cover.

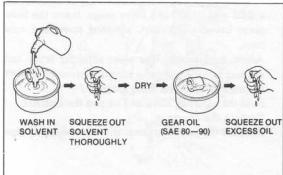

#### 5. FUEL LINES

Replace any parts which show signs of deterioration, damage or leakage.

#### 6. SPARK PLUG

1. Disconnect the spark plug cap, and remove the spark plug.
2. Visually inspect the spark plug electrodes for wear. The center electrode should have square edges and the side electrode should not be eroded. Discard the spark plug if there is apparent wear or if the insulator is cracked or chipped.

Spark Plugs vs Operating Conditions

For cold climate below 41°F (5°C)		Standard		For extended high speed operation	
ND	NGK	ND	NGK	ND	NGK
U20FS	C6H	U22FS	C7HS	U24FB	C9H

3. Adjust the spark plug gap to 0.6-0.7mm (0.024-0.028 in).
4. Reinstall the spark plug and reconnect the spark plug cap.

#### NOTE

First turn the spark plug finger tight, then tighten with a spark plug wrench.



## 7. VALVE CLEARANCE

### NOTE

Valve clearance adjustment must be performed while the engine is cold (below 32°C, 95°F).

1. Remove the generator cover and valve adjusting caps.
2. Rotate the flywheel counterclockwise and align the "T" mark on the flywheel with the index mark on the crankcase cover. The piston must be at T.D.C. of the compression stroke.
3. Measure the intake and exhaust valve clearances with a 0.05 mm (0.002 in.) feeler gauge. Insert the feeler gauge between the valve adjusting screw and valve stem.
4. Adjust by loosening the valve adjusting screw lock nut and turning the valve adjusting screw until there is a slight drag on the feeler gauge.
5. Hold the adjusting screw and tighten the lock nut.
6. Recheck the clearance.
7. Reinstall the generator cover and valve adjusting caps.

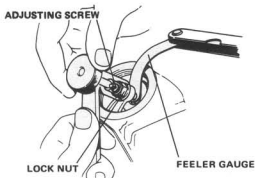
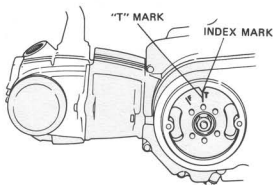

## 8. CONTACT BREAKER POINT GAP AND IGNITION TIMING

### NOTE

Adjustment of the point gap and ignition timing are made at one time.

1. Remove the generator cover.
2. Inspect the contact point surfaces. If they are level but grayish in color or are slightly pitted, file or sand them lightly. If they have a noticeable transfer of metal from one surface to the other, have evidence of heavy arcing, or are worn at an angle, the point set should be replaced.
3. Disconnect the A.C. generator wires.
4. Connect a continuity light to the black lead and to a positive battery terminal.
5. Connect the negative battery terminal to a convenient frame ground.
6. Rotate the flywheel counterclockwise and align the "F"-mark on the flywheel with the index mark on the crankcase cover.

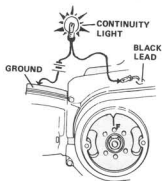
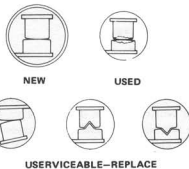

The timing is correct if the light becomes dim when both marks align.

7. If ignition timing is incorrect, loosen the contact breaker locking screw and adjust the breaker point gap. Increasing the gap will advance ignition timing. Decreasing the gap will retard ignition timing.
8. Tighten the locking screw and recheck the ignition timing.
9. Measure the maximum point with a feeler gauge.

Replace the contact breaker points if the timing can not be correctly adjusted while maintaining a point gap of 0.3–0.4mm (0.012–0.016 in).

10. Reconnect the A.C. generator wires.
11. Reinstall the generator cover.

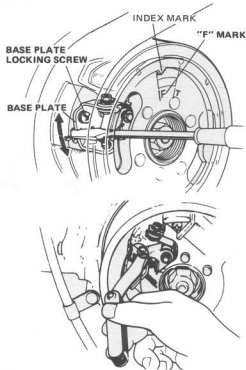

#### 9. CAM CHAIN ADJUSTMENT

1. Remove the gear change pedal. Start the engine and allow it to idle.
2. Loosen the cam chain tensioner lock nut and tensioner lock bolt 1/2 turn.
3. When the cam chain tensioner lock bolt is loosened, the tensioner will automatically position itself to provide the correct tension.
4. Tighten the cam chain tensioner lock bolt and lock nut. Install the gear change pedal.

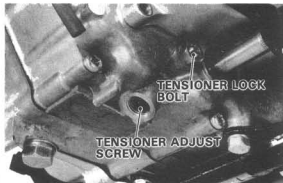

If the cam chain is still noisy, perform the following operation.

1. Loosen the cam chain tensioner lock bolt and lock nut.
2. Remove the 14mm sealing bolt located at the left bottom side of the crankcase.
3. Screw in the tensioner screw gradually until the noise ceases.
4. Tighten the tensioner lock bolt, lock nut and 14mm sealing bolt.

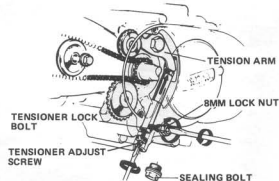

## 10. THROTTLE OPERATION

1. Check that the throttle grip free play is 2–6mm (1/8–1/4 in) measured at the throttle grip flange. Inspect the throttle cable for kinks, chafing or improper routing.
2. Check for smooth rotation and closing tension of the throttle grip in all steering positions.
3. Adjust or replace the throttle cable if necessary. Adjustment is made with either the upper or lower cable adjusters.

### NOTE

Install the rubber cap after adjusting the throttle cable.

## 11. CARBURETOR IDLE SPEED

1. Support the motorcycle upright. Warm up the engine and determine if the engine idle speed is  $1,300 \pm 100$  rpm with the transmission in neutral.

### NOTE

The engine must be warm, for idle adjustment. Ten minutes of stop and go driving should be sufficient.

2. Adjust the engine idle speed with the throttle stop screw.

### CAUTION

The pilot screw is factory pre-set. Do not adjust the pilot screw unless the carburetor overhauled or a high altitude main jet is installed (see page 95).

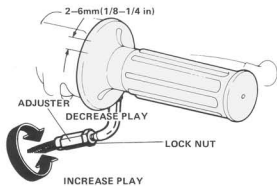

## 12. CARBURETOR CHOKE

1. Loosen the intake pipe clamp screw. Remove the air cleaner assembly mounting upper bolt and lower nut. Remove the air cleaner assembly. Check the choke lever for smooth operation and that the choke plate opens and closes fully. Inspect the choke plate for damage. Install the air cleaner assembly.



**13. DRIVE CHAIN****NOTE**

Perform the following Inspection and Adjustment with the ignition switch off.

1. Place the motorcycle on its side-stand and shift the transmission into neutral.
2. Measure the drive chain free play midway between the sprockets on the lower chain run.

**FREE PLAY:** 15–25mm (5/8–1 in)

Adjust as follows:

- 1: Remove the rear axle nut cotter pin, and loosen the axle nut.
2. Turn the adjusting nuts on both adjusters as required to obtain the correct drive chain free play.

**NOTE**

Be sure that the index mark aligns with the same graduation of the scale on both sides.

3. Tighten the axle nut and install a new cotter pin.
- TORQUE:** 3.5–5.0 km-m (25–36 ft-lb)
4. Lubricate the drive chain.

**LUBRICATION****NOTE**

Commercial aerosol type drive chain lubricants are recommended.

When the drive chain becomes extremely dirty, it should be removed and cleaned prior to lubrication. Remove the master link retaining clip.

**NOTE**

Do not bend or twist the clip. Remove the master link.

Remove the drive chain. Clean the drive chain with non-flammable or high flash point solvent and brush and allow to dry. Inspect the drive chain for possible wear or damage. Replace any chain that is damaged or excessively worn.

Inspect the sprocket teeth for excessive wear or damage. Replace if necessary.

**NOTE**

Never install a new drive chain on worn sprockets or a worn chain on new sprockets. Both chain and sprockets must be in good condition, or the new replacement chain or sprockets will wear rapidly.

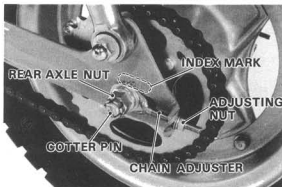
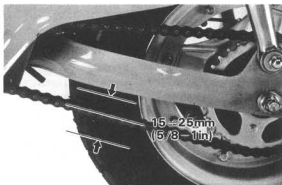

Lubricate the drive chain. Saturate each chain link joint.

Install the drive chain.

Install the master link.

Install the master link retaining clip so that the closed end faces the direction of forward wheel rotation.

Master links are reusable, if they remain in excellent condition, but it is recommended that a new master link be installed whenever the drive chain is re-assembled.

Adjust the drive chain. (page 83)

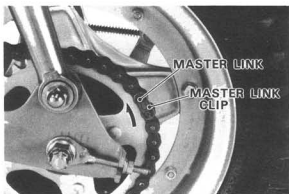

#### 14. BATTERY

1. Release the seat latch and raise the seat.
2. Remove the battery cover and retaining strap. Raise the battery to check the fluid level.
3. Add distilled water to the upper level mark. The electrolyte level must be maintained between the upper and lower level marks.
4. If sulfation forms or sediments (paste) accumulate on the bottom, replace the battery.

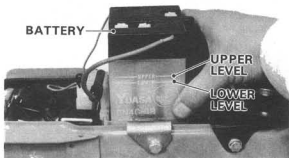

#### NOTE

Add distilled water only.  
Tap water will shorten the service life of the battery.

#### WARNING

The battery electrolyte contains sulfuric acid. Protect your eyes, skin and clothing.  
In case of contact, flush thoroughly with water and call a doctor if electrolyte contacts your eyes.

#### 15. BRAKE SHOE WEAR

1. Replace the brake shoes if the arrow on the brake arm aligns with the reference mark "Δ" on full application of the front and rear brakes.

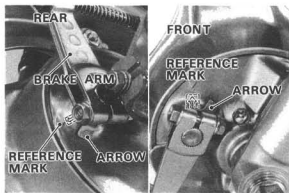

## 16. BRAKE SYSTEM

## FRONT BRAKE FREE PLAY

1. Measure the brake lever free play at the lever end.

**BRAKE LEVER FREE PLAY:**  
20–30 mm (3/4–1 1/4 in)

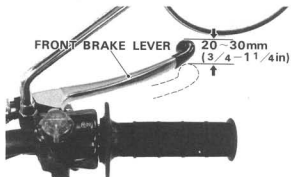

2. Minor adjustments are made with the upper adjuster. Loosen the lock nut and turn the adjuster. Tighten the lock nut.

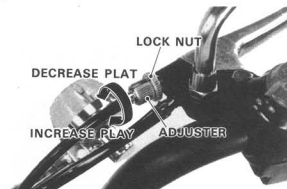

3. Adjust by using the adjusting nut located at the front wheel.
4. Recheck the brake operation and lever free play.



## REAR BRAKE FREE PLAY

1. Check the brake pedal free play.  
**FREE PLAY:** 20–30mm (3/4–1 1/4 in)

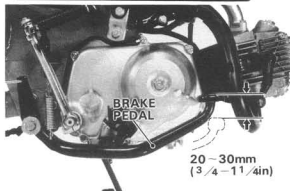

2. Adjust by turning the rear brake adjusting nut.

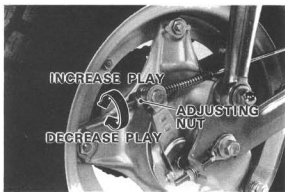

#### BRAKE LINKAGE INSPECTION

1. Check the front brake cable and brake lever for loose connection, excessive play, bending or damage. Replace or repair if necessary.
2. Inspect the rear brake rod and stopper arm for loose connections or damage.

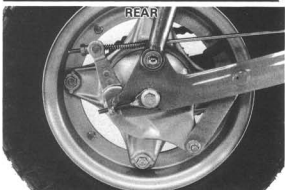
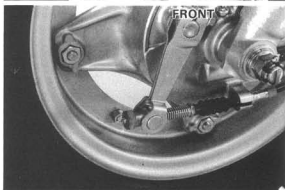

#### 17. BRAKE LIGHT SWITCH

1. Adjust the brakelight switch so that the brakelight will come on when the brake pedal is depressed 20 mm (3/4 in) where the brake begins engagement. Adjust by turning the switch adjusting nut.

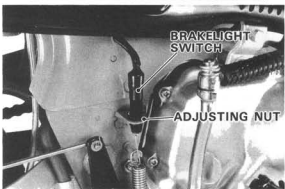



**18. HEADLIGHT AIM**

The headlight beam can be adjusted vertically and horizontally.

1. Adjust vertically by loosening the headlight mounting bolts.
2. Adjust the horizontal beam with the beam adjusting screw shown.

**NOTE**

Adjust the headlight beam as specified by local laws and regulations.

**WARNING**

An improperly adjusted headlight may blind oncoming drivers, or it may fail to light the road for a safe distance.

**19. CLUTCH ADJUSTMENT**

Adjustment of the clutch should be made with the engine stopped.

1. Loosen the adjusting screw lock nut.
2. Turn the adjusting screw counterclockwise one turn.
3. Slowly turn the adjusting screw clockwise until a resistance is felt.
4. Then turn the adjusting screw counterclockwise 1/8–1/4 turn, and tighten the lock nut.

**NOTE**

The engine should start easily with the kick starter without the clutch slipping. When changing gears, clutch operation should be smooth and light, especially when shifting to neutral.

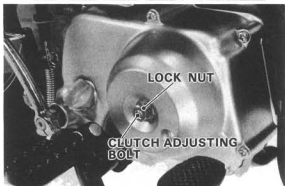
**20. SIDE STAND**

1. Check the rubber pad for deterioration or wear.
2. Replace if any wear extends to wear line as shown.
3. Check the side stand spring for damage or loss of tension, and the side stand assembly for freedom of movement and bend.

**NOTE**

- When replacing use a rubber pad with the mark "BELOW 259 lbs. ONLY".
- Spring tension is correct if the measurements fall within 2–3 kg (4.4–6.6 lb) when pulling the side stand lower end using a spring scale.

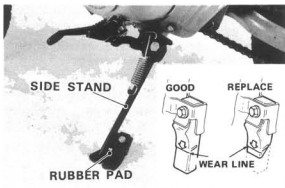

## 21. SUSPENSION

### FRONT

1. Check the action of the front forks by compressing them several times.  
Check the entire fork assembly for signs of leaks, or damage. Replace any components which are not repairable.
2. Tighten all bolts to correct torque values.
3. Check front wheel trueness.

### REAR

1. Place the motorcycle on a support block to raise the rear wheel.
2. Move the rear wheel sideways with force to see if the rear fork bushings are worn. Replace if excessively worn.
3. Check the entire suspension assembly to see if it is securely mounted.
4. Check for damage and replace any components as required.
5. Check the rear wheel for trueness.

## 22. SPARK ARRESTER

Clean the spark arrester periodically.

1. Remove the spark arrester mounting bolt.
2. Remove the spark arrester.
3. Start the engine and remove carbon from the muffler by momentarily revving up the engine.
4. Clean the spark arrester with a wire brush.
5. Reinstall the spark arrester and mounting bolt.

### WARNING

- Do not perform this operation immediately after the engine has been run because the exhaust system becomes very hot.
- Because of the increased fire hazard ensure that there are no combustible materials in the area while cleaning the spark arrester.
- Exhaust gases contain poisonous carbon monoxide. Perform this operation only in a well ventilated area.
- Wear eye protection.

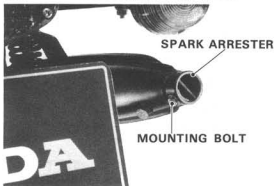
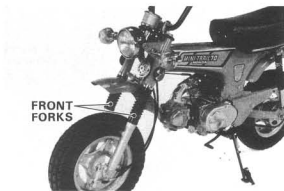

**23. WHEELS****TIRE PRESSURE**

Check the tires for cuts, imbedded nails, or other objects.

**NOTE**

Tire pressure should be checked when the tires are **COLD**.

Tire Pressures kg/cm <sup>2</sup> (psi)	Front: 1.25 (18) Rear: 1.5 (21)
Vehicle capacity load limit	100 kg (220 lbs)
Tire size	Front: 4.00-10 Rear: 4.00-10

**WARNING**

Replace tires when tread depth becomes less than 3mm (1/8 in).

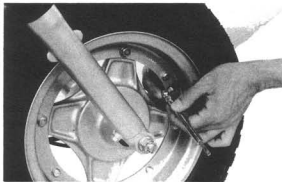
**24. STEERING HEAD BEARING**

Check that the control cables do not interfere with the rotation of the handlebar.

Raise the front wheel off the ground.

Turn the front wheel left and right with the handlebar.

If it moves unevenly, binds, or has vertical movement, adjust the steering head bearing by turning the steering head adjusting nut with a pin spanner. (07902-0010000, HC06155).

**25. NUTS, BOLTS, FASTENERS**

Retighten the bolts, nuts and fasteners at the regular intervals shown in the Maintenance Schedule.

Check that all chassis nuts and bolts are tightened to their correct torque value. Check all cotter pins and safety clips.

## VI. CARBURETOR

### WARNING

Gasoline is extremely flammable and is explosive under certain conditions. Do not smoke or allow flames or sparks in your working area.

### NOTE

When disassembling fuel system parts, note the locations of the O-rings.  
Replace them with new ones on reassembly. The float bowl has a drain plug that can be loosened to drain residual gasoline.

### DISASSEMBLY

Turn the fuel valve OFF and disconnect the fuel line. Loosen the carburetor band screw and flange nuts.

Remove the carburetor.

Loosen the carburetor cap and remove the throttle valve, spring, and jet needle.

Disconnect the throttle cable.

Remove the fuel valve and strainer.

Remove the float chamber body.

Remove all remaining parts.

Inspect the main and slow jets for clogging. Blow clear with compressed air if necessary.

Inspect the fuel valve and strainer, and clean as necessary.

Inspect the float valve, pilot screw, jet needle, and needle jet for deposits, grooving, or damage and clean or replace as required.

### ASSEMBLY

Assembly is essentially the reverse of disassembly.

### NOTE

Adjust the float level by carefully bending the float arm until the tang lightly contacts the float valve at the specified measurement.

**FLOAT LEVEL:** 10.7 mm (0.42 in)

After assembly, perform the following:

Install carburetor.

Adjust the pilot screw (page 91) and engine idle speed (page 82).

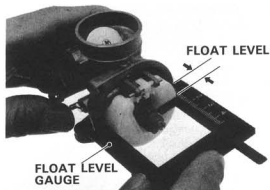
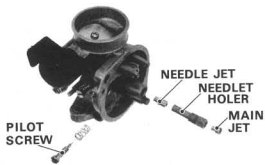
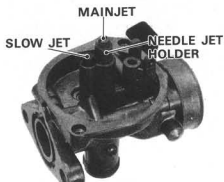

**PILOT SCREW ADJUSTMENT****NOTE**

The pilot screw is factory pre-set. Adjustment is not necessary unless the carburetor is overhauled or a high altitude main jet is installed.

1. Turn the pilot screw clockwise until it seats lightly back it out 1–3/4 turns. This is a preliminary setting prior to the final Pilot Screw Adjustment.

**CAUTION**

Damage to the pilot screw seat will occur if the pilot screw is tightened against the seat.

2. Warm up the engine to operating temperature. Stop and go driving for ten minutes is sufficient.
3. Attach a tachometer.
4. Adjust the idle speed with the throttle stop screw.  
IDLE SPEED: 1,300 ± 100 rpm
5. Screw the pilot screw in gradually until the engine stops.
6. Turn the pilot screw 3/4 of a turn out from this position.
7. Restart the engine and readjust the idle speed with the throttle stop screw if necessary.

**HIGH ALTITUDE ADJUSTMENT**

The carburetor must be adjusted for high altitude riding (2,000 M, 6,500 ft).

STANDARD SETTING : 2,000m (6,500 ft) max.

HIGH ALTITUDE SETTING : 1,500m (5,000 ft) min.

Carburetor adjustment is as follows:

1. Remove the carburetor
2. Remove the float bowl.
3. Replace the main jet with the high altitude type.
4. Assemble and install the carburetor.
5. Screw in the pilot screw 1/8 of a turn.
6. Start the engine and adjust the idle speed with the throttle stop screw.

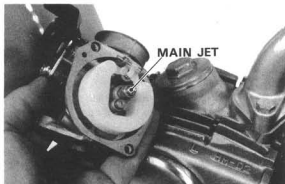
**NOTE**

Readjust the pilot screw if the engine idles rough, misses, or stalls, according to the instructions on page 21.

**CAUTION**

Sustained operation at altitudes lower than 1,500 meters (5,000 ft) with the high altitudes specifications may cause engine overheating and damage.

Reinstall the standard main jet and turn the pilot screw 1/8 turn out when operating the vehicle below 1,500 meters (5,000 ft).

Altitude	Main jet	Pilot screw
Below 5,000 feet (1,500 m)	#55	Factory-set
Above 6,500 feet (2,000 m)	#52	1/8 turn in from factory setting

## VII. HANDLEBAR

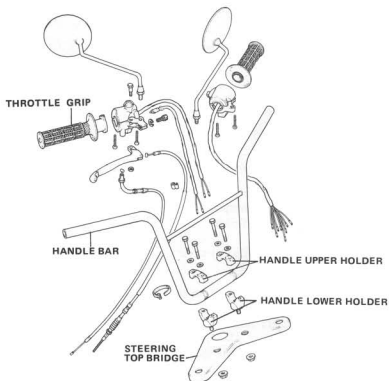

## DISASSEMBLY

- (1) Remove the headlight and disconnect the switch wires at the connectors.
- (2) Disconnect the front brake cable.
- (3) Disconnect the throttle cable.
- (4) Remove the bolts attaching the handlebar upper holders, and remove the handlebar.



## ASSEMBLY

Assembly is essentially the reverse of removal.

## NOTE

Align the punch marks on the handlebar with the top of the holders. Install each holder with the punch mark facing the rear.



## VIII. CRANKCASE BREATHER

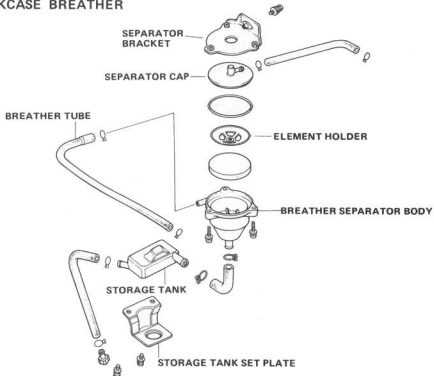

## DISASSEMBLY

- (1) Remove the engine.
- (2) Remove the bolt attaching the breather separator bracket.
- (3) Disconnect the breather tube.
- (4) Remove the storage tank set plate.
- (5) Remove the breather separator and storage tank.

## ASSEMBLY

Assembly sequence is essentially the reverse of removal.

## NOTE

Install the breather tube as shown.

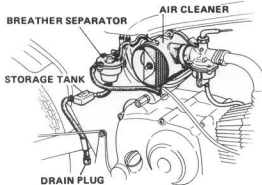

## IX. CABLE ROUTING

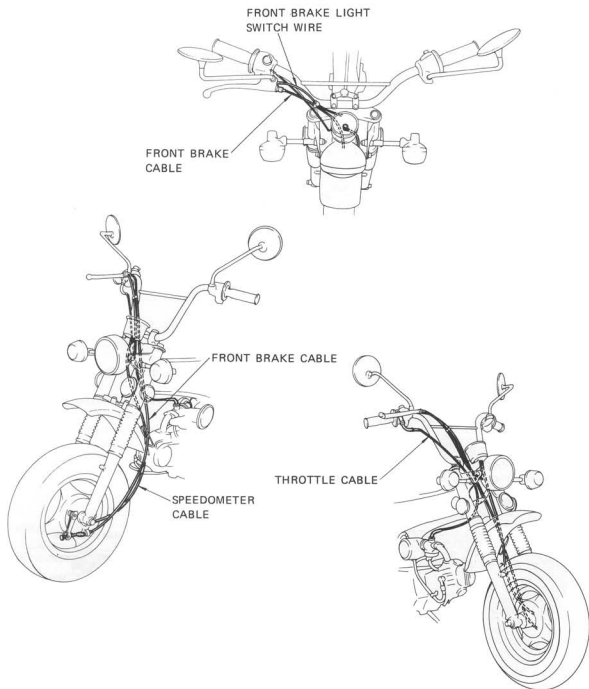



## INTRODUCTION

### INCLUDED IN THIS ADDENDUM:

- New pilot screw maintenance procedures are described.
- Maintenance procedures for the new front forks and rear shock absorbers.
- Maintenance Schedule; the spark plug and contact breaker points now require earlier replacement.

ALL INFORMATION, ILLUSTRATIONS, DIRECTIONS AND SPECIFICATIONS INCLUDED IN THIS PUBLICATION ARE BASED ON THE LATEST PRODUCT INFORMATION AVAILABLE AT THE TIME OF APPROVAL FOR PRINTING. HONDA MOTOR CO., LTD. RESERVES THE RIGHT TO MAKE CHANGES AT ANY TIME WITHOUT NOTICE AND WITHOUT INCURRING ANY OBLIGATION WHATEVER.

NO PART OF THIS PUBLICATION MAY BE REPRODUCED WITHOUT WRITTEN PERMISSION.

## CONTENTS

I.	SPECIFICATIONS .....	97
II.	SPECIAL TOOLS .....	99
III.	WIRING DIAGRAM .....	100
IV.	MAINTENANCE SCHEDULE .....	101
V.	INSPECTION AND ADJUSTMENT .....	102
	1. SPARK PLUG .....	102
	2. ENGINE OIL .....	102
	3. FRONT BRAKE .....	102
VI.	FUEL SYSTEM .....	103
	1. SPECIFICATIONS .....	103
	2. PILOT SCREW REMOVAL/INSTALLATION .....	103
	3. PILOT SCREW ADJUSTMENT .....	104
	4. FLOAT LEVEL ADJUSTMENT .....	104
	5. HIGH ALTITUDE ADJUSTMENT .....	104
	6. THROTTLE CABLE LUBRICATION .....	104
VII.	INSTRUMENTS .....	105
VIII.	FRONT FORKS .....	105
IX.	SHOCK ABSORBERS .....	109
X.	CHAIN GUIDE .....	109
XI.	BATTERY .....	110
XII.	A.C. GENERATOR .....	110
XIII.	CONDENSER .....	110
XIV.	TURN SIGNALS .....	110
XV.	CABLE ROUTING .....	111

## I. SPECIFICATIONS

DIMENSIONS	Overall length Overall width Overall height Wheel base Seat height Foot peg height Ground clearance Dry weight	1,515 mm (59.6 in) 685 mm (27.0 in) 995 mm (39.2 in) 1,050 mm (41.3 in) 745 mm (29.3 in) 300 mm (11.8 in) 160 mm ( 6.3 in) 69.5 kg (153.2 lb)
FRAME	Type Front suspension, travel Rear suspension, travel Front tire size, pressure Rear tire size, pressure Front brake Rear brake Fuel capacity Fuel reserve capacity Caster angle Trail length Front fork oil capacity	Backbone Telescopic fork, 92.5 mm (3.64 in) Swingarm, 57 mm (2.24 in) 4.00-10-2PR, 1.25 kg/cm <sup>2</sup> (18 psi) 4.00-10-2PR, 1.5 kg/cm <sup>2</sup> (21 psi) Internal expanding shoe Internal expanding shoe 2.5 lit (0.66 US gal, 0.54 Imp. gal) 0.5 lit (0.13 US gal, 0.11 Imp. gal) 63° 70 mm (2.75 in) 52.5~57.5 cc (1.85~2.03 ozs)
ENGINE	Type Cylinder arrangement Bore and stroke Displacement Compression ratio Valve train Oil capacity Lubrication system Air filtration Compression pressure Intake valve Opens Closes Exhaust valve Opens Closes Valve clearance IN, EX Idle speed	Air cooled 4-stroke OHC engine Single cylinder 80° inclined from Vertical 47.0x41.4 mm (1.85x1.63 in) 72 cm <sup>3</sup> (4.4 cu in) 8.8 Chain driven overhead camshaft 0.8 lit (0.8 US qt, 0.7 Imp. qt) Forced and wet sump Oiled polyurethane foam 12.0 kg/cm <sup>2</sup> -1,000 rpm 7.5° BTDC (At 1.05 mm lift) 12.5° ABDC (At 1.05 mm lift) 22.5° BBDC (At 1.05 mm lift) 2.5° BTDC (At 1.05 mm lift) 0.05 mm (0.002 in) 1,500±100 rpm
CARBURETION	Carburetor type Setting number Pilot screw initial opening Float level	Piston valve, venturi dia. 13 mm PB 37B 1¼ (page 91, 104) 10.7±1 mm (0.42±0.04 in)

DRIVE TRAIN	Clutch Transmission Primary reduction ratio Gear ratio I II III Final reduction ratio Gear shift pattern	Wet multi-plate automatic (Centrifugal) 3-speed constant mesh 4.058 3.272 1.722 1.190 2.333 Left foot operated return system
ELECTRICAL	Ignition Ignition timing (F mark) Point gap Starting system Alternator Battery capacity Spark plug U.S.A. model Canadian model Spark plug gap Headlight (low/high beam) Tail/stoplight Turn signal Speedometer light Neutral indicator Turn signal indicator High beam indicator	Flywheel magneto 27° BTDC (Fixed) 0.3–0.4 mm (0.012–0.016 in) Kick starter Flywheel 60W/5,000 rpm 6V–4AH C7HS [NGK], U22FS [ND] CR7HS [NGK], U22FSR-L [ND] 0.6~0.7 mm (0.024~0.028 in) 6V–15/15W 6V–5.3/25W (3/32 cp) 6V–18W (21 cp) SAE TRADE NO. 1129 6V–1.7W (1 cp) SAE TRADE NO. 51 6V–3W (2 cp) SAE TRADE NO. 55 6V–1.7W (1 cp) SAE TRADE NO. 51 6V–1.7W (1 cp) SAE TRADE NO. 51

## II. SPECIAL TOOLS/Common Tools

## SPECIAL TOOLS

Tool Name	Tool No.
Clutch outer holder (For HITACHI A.C. generator flywheel)	07923-040000
Flywheel holder (For ND A.C. generator flywheel)	07925-0010001
Ball race driver	07944-1150001
Shock absorber spring holder	07967-1180100
Valve guide reamer	07984-0980000

## COMMON TOOLS

Tool Name	Tool No.	Apropriation List (Common tool→Special tool)
Floot level gauge	07401-0010000	←
Pin spanner	07702-0010000	Pin spanner (36 mm) 07902-0010000
Tappet adjusting wrench (8x9 mm)	07708-0030100	} Tappet adjusting wrench 07908-0010000
Tappet adjusting (B)	07708-0030400	
Lock nut wrench (20x24 mm)	07716-0020100	
Extension bar & handle	07716-0020500	
Flywheel puller	07733-0010000	Flywheel puller 07933-0010000
Valve guide remover (5.5 mm)	07742-0010100	Valve guide remover 07942-3290100
Valve guide driver (A)	07742-0020100	Valve guide driver 07942-1180100
Valve guide cutter	07742-0030100	←
Valve guide cutter pilot (5.5 mm)	07742-0030200	←
Bearing driver outer (37x40 mm)	07746-0010200	Bearing driver attach 07946-3640000 (07946-0980000)
Bearing driver handle (B)	07746-0020100	
Bearing driver inner (20 mm)	07746-0020400	
Bearing driver pilot (12 mm)	07746-0040200	
Bearing driver pilot (17 mm)	07746-0040400	
Fork oil seal driver body	07747-0010100	} Fork seal driver 07947-1310000
Fork oil seal attachment (A)	07747-0010200	
Bearing driver handle (A)	07749-0010000	Bearing driver handle 07949-6110000 (07949-3000000)
Valve spring compressor	07757-0010000	Valve spring compressor 07957-3290001
Shock absorber dis/assembly tool	07959-3290001	←
Valve seat cutter 32°	07780-0012000	} Valve seat grinder 37.5° [IN.] 07783-0030400 } Valve seat grinder 37.5° [EX.] 07783-0030300
Valve seat cutter 45°	07780-0010200	
Valve seat cutter 60°	07780-0014000	Valve seat grinder 45° 07783-0040400
Valve seat cutter holder (5.5 mm)	07781-0010100	Valve seat grinder 63.5° 07783-0050200 Seat grinder pilot A 07783-0010100

## III. WIRING DIAGRAM

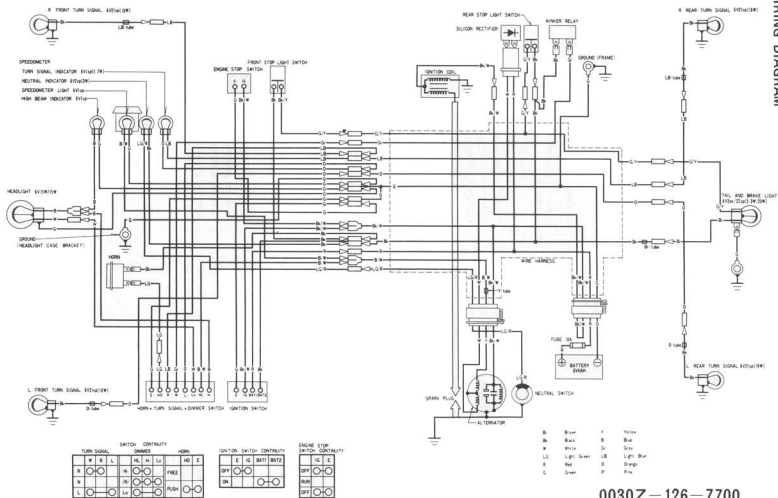

0030Z-126-7700

## IV. MAINTENANCE SCHEDULE

Perform the PRE-RIDE INSPECTION in the Owner's Manual at every maintenance period.

I : Inspect and Clean, Adjust, Lubricate or Replace if necessary.  
 C : Clean  
 R : Replace  
 A : Adjust  
 L : Lubricate

FREQUENCY		WHICHEVER COMES FIRST ↓	ODOMETER READING [NOTE 3]					Refer to Page
			EVERY	600 mi (1,000 km)	2,500 mi (4,000 km)	5,000 mi (8,000 km)	7,500 mi (12,000 km)	
ITEM								
	EMISSION RELATED ITEMS	• FUEL LINES			I	I	I	79
• THROTTLE OPERATION			I	I	I	I	82	
• CARBURETOR CHOKE				I	I	I	82	
AIR CLEANER		NOTE (1)		C	C	C	79	
CRANKCASE BREATHER (USA only)		NOTE (2)		C	C	C	78	
SPARK PLUG				R	R	R	79,102	
• VALVE CLEARANCE			I	I	I	I	80	
• CONTACT BREAKER POINTS			I	I	R	I	80	
• IGNITION TIMING			I	I	I	I	80	
ENGINE OIL		YEAR	R	REPLACE EVERY 1,250 mi. (2,000 km)			77,102	
NON-EMISSION RELATED ITEMS	• ENGINE OIL FILTER SCREEN			C			78	
	• CAM CHAIN TENSION		A	A	A	A	81	
	• CARBURETOR IDLE SPEED		I	I	I	I	84,110	
	DRIVE CHAIN		I, L EVERY 300 mi (500 km)				83	
	BATTERY	MONTH	I	I	I	I	84	
	BRAKE SHOE WEAR			I	I	I	84	
	BRAKE SYSTEM		I	I	I	I	85	
	• BRAKE LIGHT SWITCH		I	I	I	I	86	
	• HEADLIGHT AIM		I	I	I	I	87	
	CLUTCH		I	I	I	I	87	
SIDE STAND			I	I	I	87		
• SUSPENSION		I	I	I	I	88		
• SPARK ARRESTER			C	C	C	88		
• NUTS, BOLTS, FASTENERS		I	I	I	I	89		
** WHEELS		I	I	I	I	89		
** STEERING HEAD BEARING		I			I	89		

- SHOULD BE SERVICED BY AN AUTHORIZED HONDA DEALER, UNLESS THE OWNER HAS PROPER TOOLS AND SERVICE DATA AND IS MECHANICALLY QUALIFIED.
- \*\* IN THE INTEREST OF SAFETY, WE RECOMMEND THESE ITEMS BE SERVICED ONLY BY AN AUTHORIZED HONDA DEALER.

NOTES: (1) More frequent service may be required when riding in dusty areas.  
 (2) More frequent service may be required when riding in rain or at full throttle.  
 (3) For higher odometer readings, repeat at the frequency interval established here.

## V. INSPECTION AND ADJUSTMENT

### 1. SPARK PLUG

1. Disconnect the spark plug cap.
2. Remove and discard the spark plug.
3. Measure the new spark plug gap with a wire type feeler gauge.

SPARK PLUG GAP: 0.6–0.7 mm (0.024–0.028 in)

If adjustment is necessary, bend the side electrode carefully.

4. With the plug washer attached, thread the new spark plug in by hand to prevent cross-threading.
5. Tighten the spark plug 1/2 turn with a spark plug wrench to compress the washer.
6. Reinstall the spark plug cap.

#### RECOMMENDED SPARK PLUG

	USA model	Canadian model
Standard	C7HS (NGK) U22FS (ND)	CR7HS (NGK) U22FSR-L (ND)
For cold climate below 41°F (5°C)	C6H (NGK) U20FS (ND)	CR6HS (NGK) U20FSR-L (ND)
For extended high speed driving	C9H (NGK) U24FB (ND)	CR8HS (NGK) U24FSR-L (ND)

### 2. ENGINE OIL

#### RECOMMENDED OIL:

HONDA 4-STROKE OIL or equivalent

All Service Classification: SE

VISCOSITY: SAE 10W–40

Other oil viscosities may be used when the average temperature in the owner's riding area is within the indicated range.

#### ENGINE OIL CAPACITY:

0.8ℓ (0.8 US qt, 0.7 Imp qt) at draining

### 3. FRONT BRAKE

#### LUBRICATION

Periodically disconnect the brake cable and lubricate with a commercially available cable lubricant to prevent premature wear.

#### FREE PLAY

1. Measure the brake lever free play at the lever end.

#### FREE PLAY:

20–30 mm (3/4–1 1/4 in)

2. Adjust by using the adjusting nut located at the front wheel.
3. Recheck the brake operation and lever free play.

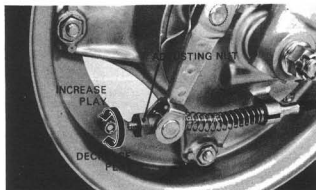
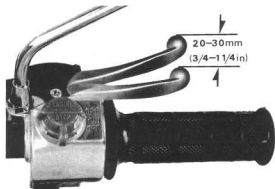
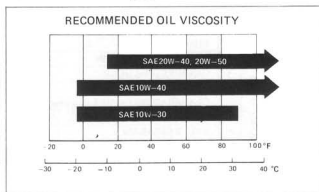
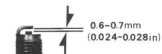



## VI. FUEL SYSTEM

### 1. CARBURETOR SPECIFICATIONS

Identification No.	PB37B
Idle Speed	1,500±100 rpm
Float Level	10.7±1 mm (0.42±0.04 in)
Pilot Screw	1¾ (page 91, 104)

### 2. PILOT SCREW REMOVAL/INSTALLATION

#### NOTE

- The pilot screw is factory pre-set and should not be removed unless the carburetor is overhauled.
- A pilot screw limiter cap is used to prevent pilot screw tampering. (U.S.A. only)

#### CAUTION

Any forcible attempt to remove the pilot screw limiter cap will cause screw breakage. (U.S.A. only)

Remove the carburetor. (page 90).  
Remove the float chamber.

Turn the pilot screw in and carefully count the number of turns before it seats lightly. Make a note of this to use as a reference when reinstalling the pilot screw.

#### CAUTION

Damage to the pilot screw seat will occur if the pilot screw is tightened against the seat.

Remove the pilot screw.  
Inspect the pilot screw for wear and replace if necessary.  
Install the pilot screw and turn it to the original position, as noted during removal. Perform pilot screw adjustment if a new pilot screw is installed (Page 104).

#### NOTE

Do not install a limiter cap on a new pilot screw until after adjustment has been made (Page 104).

Install the float chamber.  
Install the carburetor.

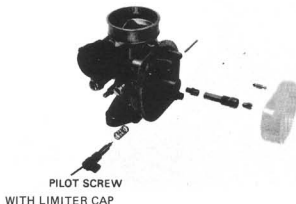
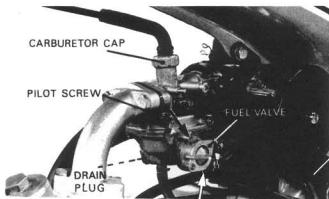

### 3. PILOT SCREW ADJUSTMENT

Adjust the pilot screw (page 91), using 1,500 rpm as the idle speed.

After final adjustment, cement the limiter cap-over the pilot screw, using LOCTITE® #601 or equivalent. The limiter cap should be placed against its stop, preventing further adjustment that would enrich the fuel mixture (limiter cap position permits clockwise rotation and prevents counterclockwise rotation).

#### NOTE

- Do not turn the pilot screw when installing the limiter caps.
- A pilot screw limiter cap must be installed. It prevents misadjustment that could cause poor performance and an exhaust emissions increase.

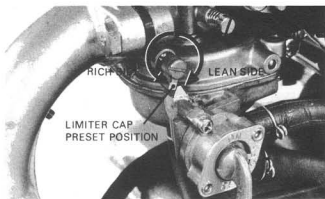

### 4. FLOAT LEVEL ADJUSTMENT

Remove the carburetor (Page 90).

Remove the float chamber.

Measure the float level. The float arm should just lightly contact the float valve, when measuring.

**FLOAT LEVEL:** 10.7±1 mm (0.42±0.04 in)

Replace the float, if it is not within specifications.

Install the float chamber.

Install the carburetor.

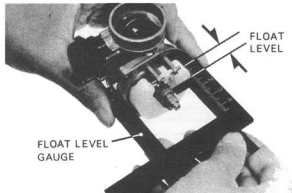

### 5. HIGH ALTITUDE ADJUSTMENT

The carburetor must be adjusted for high altitude riding above 2,000 m (6,500 ft).

**STANDARD SETTING:** 2,000 m (6,500 ft) max.

**HIGH ALTITUDE SETTING:** 1,500 m (5,000 ft) min.

Carburetor adjustment is as follows:

1. Remove the carburetor (page 90).
2. Remove the float chamber.
3. Replace the main jet with the high altitude type.
4. Assemble and install the carburetor.
5. Start the engine and adjust the idle speed with the throttle stop screw.

**IDLE SPEED:** 1,500±100 rpm

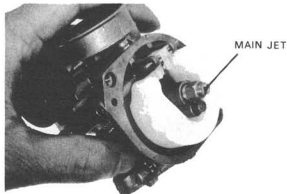

#### CAUTION

Sustained operation at altitudes lower than 1,500 meters (5,000 ft) with the high altitude specifications may cause engine overheating and damage. Reinstall the standard main jet when operating the vehicle below 1,500 meters (5,000 ft).

### 6. THROTTLE CABLE LUBRICATION

Periodically disconnect the throttle cable and lubricate with a commercially available cable lubricant to prevent premature wear.

Altitude	Main jet	Pilot screw
Below 5,000 feet (1,500 m)	#55	Factory Preset Counterclockwise against stop
Above 6,500 feet (2,000 m)	#52	Factory Preset Counterclockwise against stop

## VII. INSTRUMENTS

### 1. DISASSEMBLY

1. Remove the headlight and disconnect all connectors.
2. Remove the speedometer cable from the speedometer.
3. Remove the two bolts attaching the headlight brackets to the fork top bridge.

### 2. ASSEMBLY

Assembly of the instruments is essentially the reverse order of disassembly.

#### NOTE

Route the wire harness and speedometer cable as shown in CABLE ROUTING (Page 111).

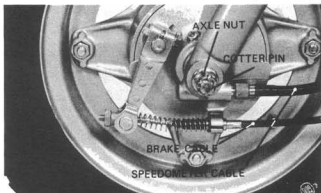
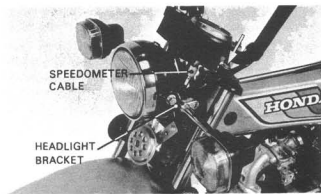

## VIII. FRONT FORK

### 1. FRONT FORK REMOVAL

Remove the front wheel (Page 40).

Unscrew the fork bolt.  
Loosen the front fork attaching bolts at the bottom fork bridge.  
Remove the fork tubes.

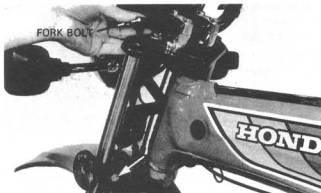

### 2. FRONT FORK DISASSEMBLY

Hold the fork tube in a vise.  
Loosen the fork spring retainer bolt.

#### CAUTION

Do not damage or bend the sliding surface.

#### WARNING

Use care when loosening the bolt or the spring will pop out.

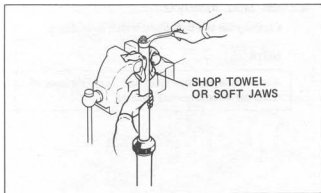

Pour out the fork fluid by compressing the fork several times.

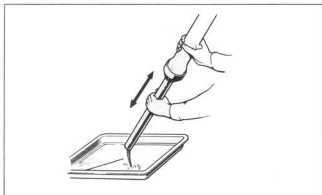

### 3. FRONT FORK SPRING FREE LENGTH INSPECTION

Measure the front fork spring free length.

SERVICE LIMIT: 423.0 mm (16.65 in)

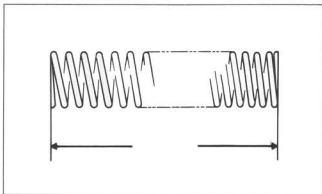

Remove the socket bolt from the bottom of the fork leg.  
Remove the fork tubes and piston.

#### NOTE

- Hold the fork slider in a vice, being careful not to tighten excessively.
- Temporarily install the spring and spring retainer bolt should difficulty be encountered in removing the bolt.

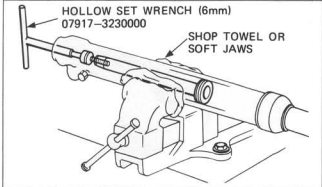

### 4. OIL SEAL REMOVAL

Carefully lift out the oil seal with a screwdriver.

#### NOTE

Avoid damaging the inner and outer surfaces of the slider when removing the seal.

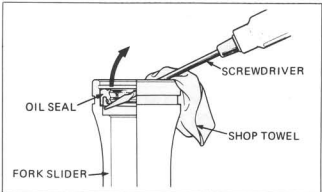

### 5. FORK TUBE/FORK SLIDER/PISTON INSPECTION

Check the fork tubes, sliders and pistons for score marks, scratches, excessive or abnormal wear, replacing parts which are damaged.

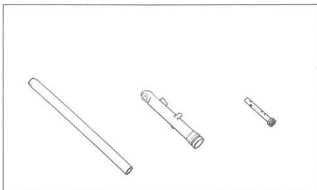

### 6. FORK TUBE INSPECTION

Set the fork tube in V blocks and read the runout. Take 1/2 TIR (Total Indicator Reading) to determine the actual runout.

SERVICE LIMIT: 0.2 mm (0.01 in)

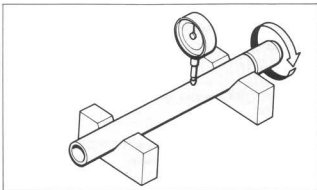

### 7. FRONT FORK ASSEMBLY

Clean all parts with solvent.

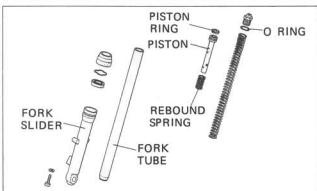

Install the pistons into the fork tubes.

Apply a locking agent to the socket bolt threads and underside of the bolt head, then tighten securely.

#### NOTE

Do not tighten the fork slider excessively in a vise.

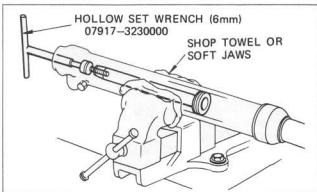

**8. OIL SEAL INSTALLATION**

Drive the oil seal into position until the snap ring groove appears.  
Install the snap ring and dust cover.

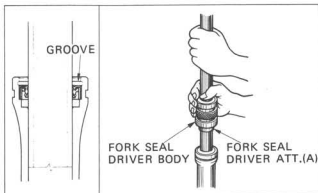
**9. FILLING WITH FORK OIL**

Use ATF (Automatic Transmission Fluid) to fill the front fork.

**NOTE**

Pour in the specified amount of ATF. Do not overfill.

**OIL CAPACITY:** 52.5~57.5 cc (1.85~2.03 ozs.)  
at disassembly.

Slide the front fork spring and spring seat into position and tighten with the spring retainer bolt.

**NOTE**

- Place the fork tube in soft jaws, avoiding the sliding surfaces.
- Note the spring direction.

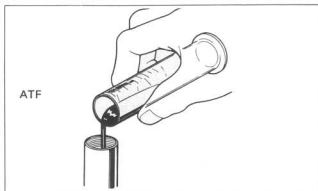
**10. FRONT FORK INSTALLATION**

Install the fork tubes in the fork top and bottom bridges while rotating them by hand.  
Ensure that each tube bears against the fork top bridge.

Tighten the right and left fork bolts to the specified torque.

**TORQUE SPECIFICATION:**  
7.0~9.0 kg-m (51~65 ft-lb)

Tighten the front fork bolts at the fork bottom bridge.

**TORQUE SPECIFICATION:**  
1.8~2.5 kg-m (13~18 ft-lb)

Install the front wheel.



## IX. SHOCK ABSORBER

### 1. DISASSEMBLY

1. Remove the shock absorber assembly by loosening the upper and lower cap nuts.
2. Remove the upper joint.

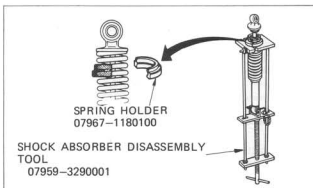

### 2. INSPECTION

Measure the shock absorber spring free length.  
**SERVICE LIMIT: 195 mm (7.68 in)**

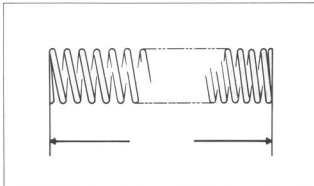

### 3. ASSEMBLY

1. Install the spring seat, stopper rubber and lock nut.

#### NOTE

- Install the spring with the narrow pitch end on the upper joint side.
- Apply **LOCTITE®** to the lock nut before installation.

2. Install and tighten the upper joint.
3. Install the shock absorber with the cap nuts.

**TORQUE SPECIFICATION:**  
 3.0–4.0 kg-m (22–29 ft-lb)

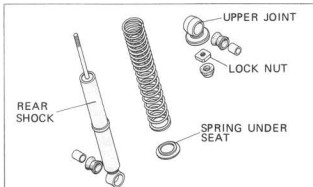

## X. CHAIN GUIDE

### 1. CONSTRUCTION

The 1980 CT70 has a chain guide which is installed on the swing arm as shown.

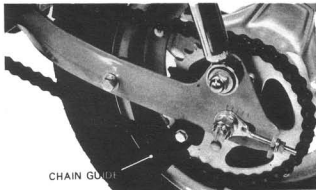

## XI. BATTERY

### 1. CONSTRUCTION

#### CAUTION

Remove the battery before leaning the motorcycle on its side.

The leak-proof battery has been discontinued for 1980.

The battery positive and negative cables now use a coupler instead of the connectors.

Battery type: 6V-4AH

Specific gravity: 1.26-1.28 (Fully charged)

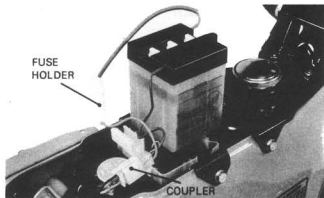

## XII. A.C. GENERATOR

### 1. CHARGING CHARACTERISTICS

Charging starts at 1,550 rpm with lights on.

Charging rate

Lights on load: 0.9 A at 4,000 rpm (8.5V)

2.2 A at 8,000 rpm (8.7V)

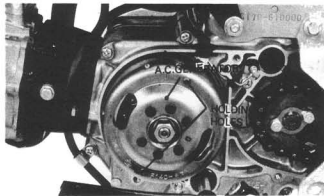

## XIII. CONDENSER

### 1. INSPECTION

1. Remove the left crankcase side cover and fly-wheel.
2. Disconnect the condenser lead from the contact breaker points.
3. Remove the screw and hold the condenser away from the A.C. generator stator plate.  
Discharge the condenser by touching the positive center lead to any case ground.
4. Measure the capacity of the condenser.

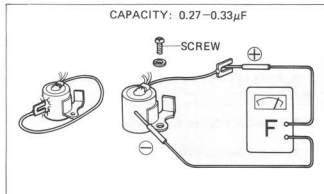

## XIV. TURN SIGNAL

### 1. DISASSEMBLY

1. Remove the turn signal lens by pressing down and out.

#### CAUTION

Do not pry with a screwdriver.

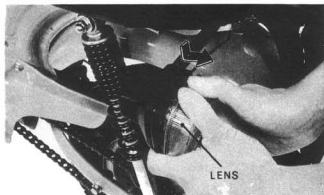



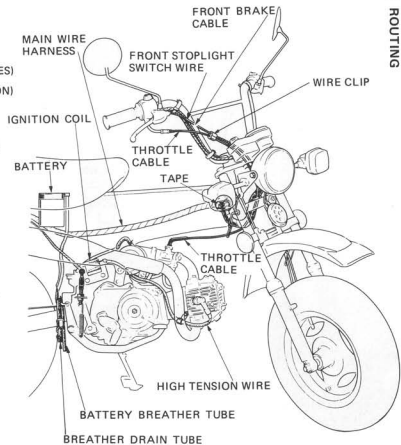
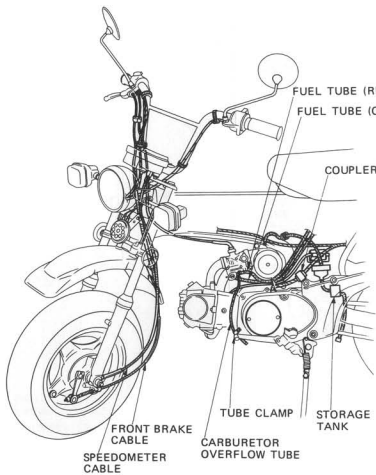

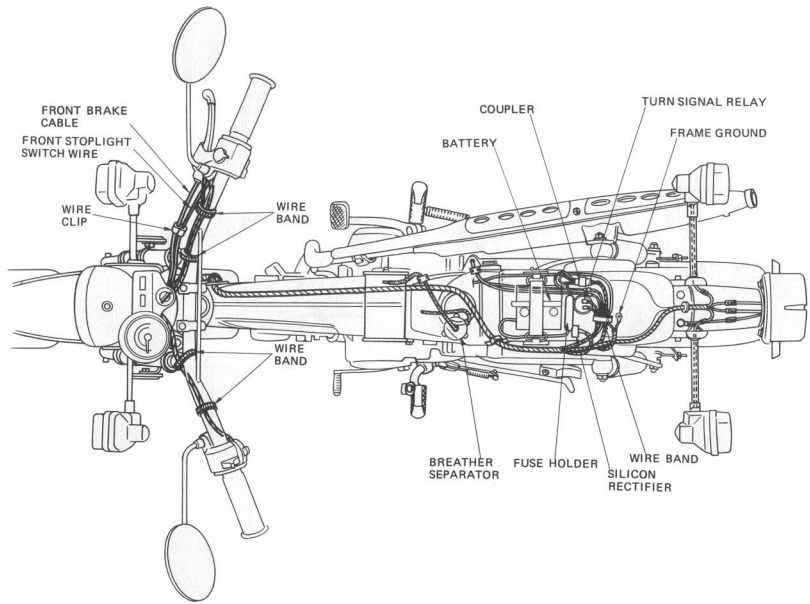

## I. MODEL IDENTIFICATION

The VIN (Vehicle Identification Number) is on the Safety Certification Label on the right side of the steering column.

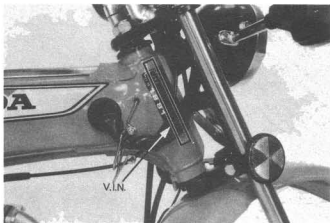

The frame serial number is stamped on the left side of the steering column.

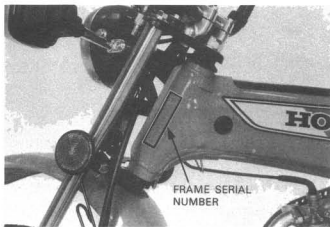

The Vehicle Emission Control Information Label is on the left side of the frame.  
(U. S. A. ONLY)



**II. BATTERY**

When removing the battery for service, leave the breather tube in the frame.

When reinstalling the battery, make sure the breather tube is securely connected to the breather outlet.

# CAUTION

PIPING AS SHOWN BELOW

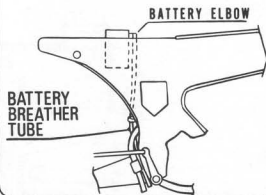

## INSERT THE BATTERY BREATHER TUBE SECURELY

1 2 6 8 7

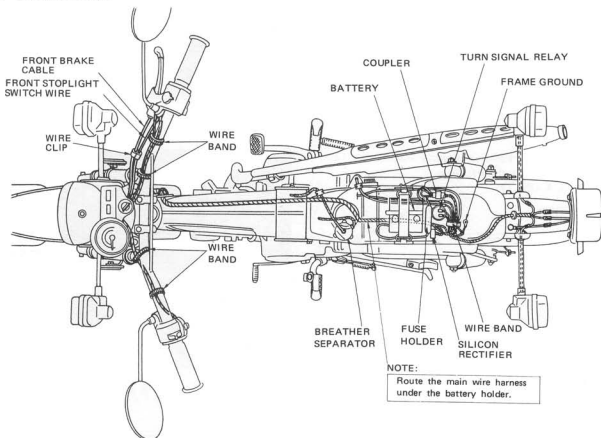
**III. CABLE ROUTING**

**INTRODUCTION**

This Honda Shop Manual addendum contains information for the 1982 CT70.

Refer to the base Shop Manual for service procedures and data not included in this addendum.

ALL INFORMATION, ILLUSTRATIONS, DIRECTIONS AND SPECIFICATIONS INCLUDED IN THIS PUBLICATION ARE BASED ON THE LATEST PRODUCT INFORMATION AVAILABLE AT THE TIME OF APPROVAL FOR PRINTING. HONDA MOTOR CO., LTD. RESERVES THE RIGHT TO MAKE CHANGES AT ANY TIME WITHOUT INCURRING ANY OBLIGATION WHATEVER.

NO PART OF THIS PUBLICATION MAY BE REPRODUCED WITHOUT WRITTEN PERMISSION.

HONDA MOTOR CO., LTD.  
Service Publications Office

**CONTENTS**

1. SPECIFICATIONS .....	116
2. MAINTENANCE SCHEDULE .....	117
3. SPARK PLUG.....	118
4. OIL RECOMMENDATION.....	118
5. FUEL SYSTEM.....	119
6. OIL PUMP.....	124
7. CYLINDER HEAD AND VALVES.....	124
8. PISTON AND PISTON RINGS.....	126
9. WIRING DIAGRAM.....	128

## 1. SPECIFICATIONS

The specifications listed below are new for the 1982 CT70. Refer to the base shop manual and addendums for complete specifications.

FRAME	Rear suspension, travel	Swingarm, 64 mm (2.52 in)
CARBURETION	Setting number	PB16A
ELECTRICAL	Spark plug Standard For cold climate below 5°C, 41°F For extended high speed operation	U22FSR-U (ND), CR7HS (NGK) U20FSR-U (ND), CR6HS (NGK) U24FSR-U (ND), CR8HS (NGK)
ENGINE	Valve clearance IN, EX (cold)	0.05 mm (0.002 in)

## 2. MAINTENANCE SCHEDULE

Perform the PRE-RIDE INSPECTION in the Owner's Manual at every maintenance period.

I: Inspect and Clean, Adjust, Lubricate or Replace if necessary.

C: Clean

R: Replace

A: Adjust

L: Lubricate

ITEM		FREQUENCY	WHICHEVER COMES FIRST ↓	ODOMETER READING (NOTE 3)				
				EVERY	600 mi (1,000 km)	2,500 mi (4,000 km)	5,000 mi (8,000 km)	7,500 mi (12,000 km)
EMISSION RELATED ITEMS	* FUEL LINES			I	I	I	79	
	* FUEL STRAINER		C	C	C	C	119	
	* THROTTLE OPERATION		I	I	I	I	82	
	* CARBURETOR CHOKE			I	I	I	82	
	AIR CLEANER	NOTE (1)		C	C	C	79	
	CRANKCASE BREATHER (USA only)	NOTE (2)		C	C	C	78	
	SPARK PLUG			R	R	R	79, 102	
	* VALVE CLEARANCE		I	I	I	I	80	
	* CONTACT BREAKER POINTS		I	I	R	I	80	
	* IGNITION TIMING		I	I	I	I	80	
	ENGINE OIL	YEAR	R	REPLACE EVERY 1,250 mi. (2,000 km)			77, 102	
	* ENGINE OIL FILTER SCREEN				C		78	
	* CAM CHAIN TENSION		A	A	A	A	81	
* CARBURETOR IDLE SPEED		I	I	I	I	84, 110		
NON-EMISSION RELATED ITEMS	DRIVE CHAIN			I, L EVERY 300 mi (500 km)			83	
	BATTERY	MONTH	I	I	I	I	84	
	BRAKE SHOE WEAR			I	I	I	84	
	BRAKE SYSTEM		I	I	I	I	85	
	* BRAKE LIGHT SWITCH		I	I	I	I	86	
	* HEADLIGHT AIM		I	I	I	I	87	
	CLUTCH		I	I	I	I	87	
	SIDE STAND			I	I	I	87	
	* SUSPENSION		I	I	I	I	88	
	* SPARK ARRESTER			C	C	C	88	
	* NUTS, BOLTS, FASTENERS		I	I	I	I	89	
	** WHEELS		I	I	I	I	89	
	** STEERING HEAD BEARING		I	I	I	I	89	

\* Should be serviced by an authorized Honda dealer, unless the owner has proper tools and service data and is mechanically qualified.

\*\* In the interest of safety, we recommend these items be serviced only by an authorized Honda dealer.

- NOTES: 1. More frequent service may be required when riding in dusty areas.  
2. More frequent service may be required when riding in rain or at full throttle.  
3. For higher odometer readings, repeat at the frequency interval established here.

### 3. SPARK PLUG

1. Disconnect the spark plug cap.
2. Clean any dirt from around the spark plug base.
3. Remove and discard the spark plug.
4. Make sure the new spark plug gap is 0.6–0.7 mm (0.024–0.028 in) using a wire-type feeler gauge. If adjustment is necessary, bend the side electrode carefully.
5. With the plug washer attached, thread the new spark plug in by hand to prevent cross-threading.
6. Tighten the spark plug 1/2 turn with a spark plug wrench to compress the washer.
7. Reinstall the spark plug cap.

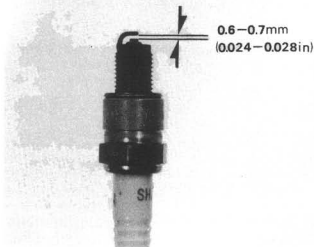

#### RECOMMENDED SPARK PLUGS

Standard	ND NGK	U22FSR-U CR6HS
For cold climate below 5°C (41°F)	ND NGK	U20FSR-U CR6HS
For extended high speed operation	ND NGK	U24FSR-U CR8HS

### 4. OIL RECOMMENDATION

Use HONDA 4-STROKE OIL or equivalent.  
API SERVICE CLASSIFICATION: SE or SF  
VISCOSITY:  
SAE 10W-40

Other oil viscosities may be used when the average temperature in the owner's riding area is within the indicated range.

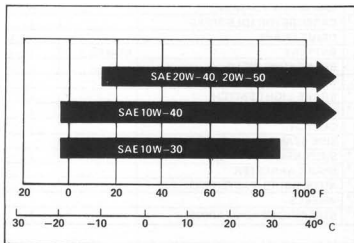



## 5. FUEL SYSTEM

### FUEL STRAINER

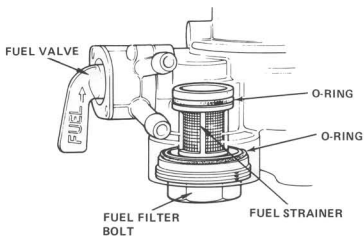

Turn the fuel valve OFF.

Loosen the carburetor drain screw and drain the fuel from the carburetor into a suitable container.

**WARNING** Gasoline is flammable and is explosive under certain conditions. Do not smoke or allow flames or sparks near the equipment while draining fuel.

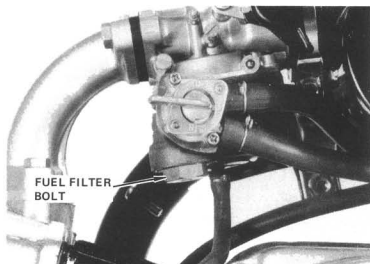

Remove the fuel filter bolt and pull out the fuel filter and O-rings.

Wash the fuel filter in clean non-flammable or high flash point solvent.

Reinstall the fuel filter and new O-rings into the fuel valve. Hand tighten the fuel filter bolt, making sure the new O-rings are in place, then torque to specification.

**TORQUE:** 0.3–0.5 kg-m (2–4 ft-lb)

**NOTE:** Do not overtighten the fuel filter bolt.

After installing, turn the fuel valve ON and check that there are no fuel leaks.

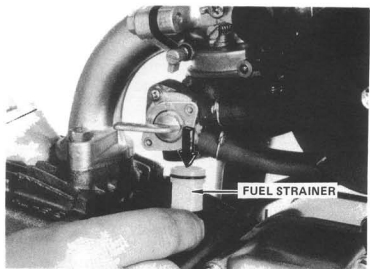

## CARBURETOR CLEANING

### GENERAL INSTRUCTIONS

- When disassembling fuel system parts, note the location of the O-rings. Replace them with new ones on reassembly.
- The carburetor float bowl has a drain plug that can be loosened to drain residual gasoline.

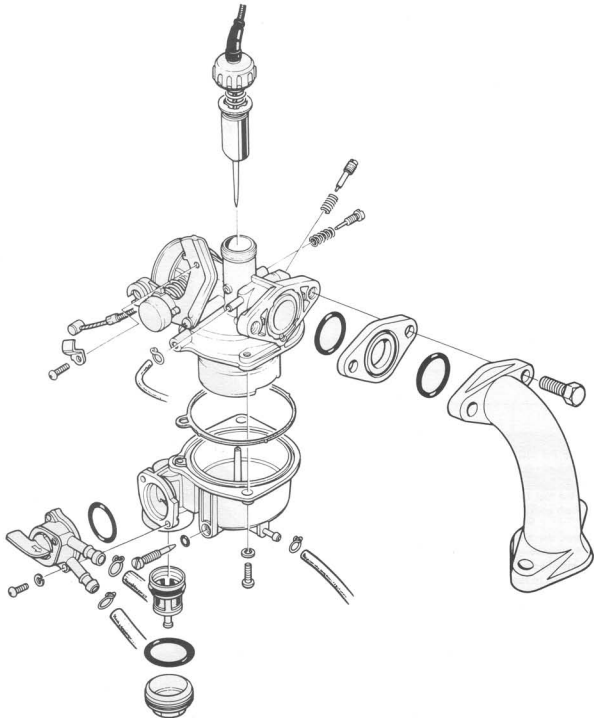

## SPECIFICATIONS

## Carburetor

Type	Piston valve
Identification number	PB16A
Jet needle setting	3rd groove
Float level	10.7 mm (0.42 in)
Pilot screw initial opening	3/4
Main jet	# 55
Slow jet	# 38
Idle speed	1,500 ± 100 rpm

## TOOL

Float level gauge	07401-0010000
-------------------	---------------

## PASSAGES AND JET CLEANING

Remove the carburetor (page 90).

Remove the float chamber body.

Turn the pilot screw in, noting the number of turns before the screw seats lightly (page 103).

Pull out the float pin and remove the float.

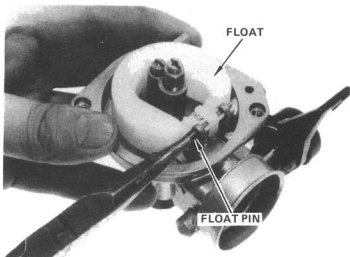

Remove the pilot screw.

Remove the float valve.

Remove the main jet and slow jet.

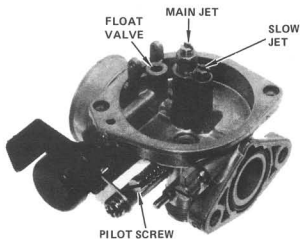

Check each part for wear or damage.

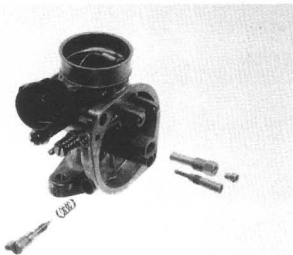

Clean the passage and jets with compressed air.

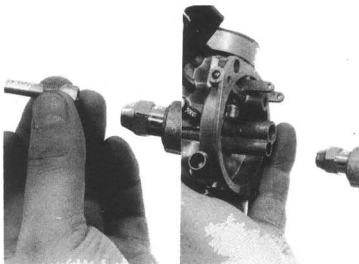

## CARBURETOR ASSEMBLY

### NOTES:

- Use new O-rings whenever the carburetor is reassembled.
- Handle all jets and needles with care. They can be easily scored or scratched.

Assemble the carburetor in reverse order of disassembly, making sure to adjust the float level (page 90), and to install and adjust the pilot screw (page 104).

## HIGH ALTITUDE

When the vehicle is to be operated continuously above 6,500 feet (2,000 m) the carburetor must be readjusted as described below to improve driveability and decrease exhaust emissions.

1. Remove the carburetor (page 90).
2. Remove the carburetor float chamber.
3. Remove the # 55 main jet and install the # 52 main jet.

### MAIN JET SPECIFICATIONS

Altitude	Main jet
Above 6,500 feet (2,000 m)	# 52
Below 5,000 feet (1,500 m)	# 55

4. Reassemble and install the carburetor.
5. Warm up the engine to operating temperature. Stop and go driving for 10 minutes is sufficient.

6. Adjust the idle speed to  $1,500 \pm 100$  rpm with the throttle stop screw.

NOTE: This adjustment must be made at high altitude to ensure proper high altitude operation.

7. Attach the Vehicle Emission Control Information Update label as shown.

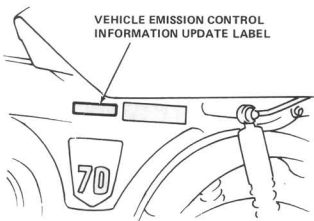
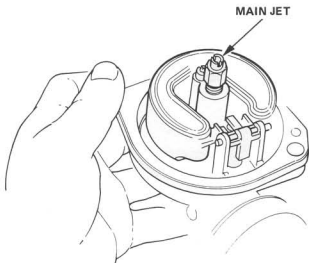

#### VEHICLE EMISSION CONTROL INFORMATION UPDATE HONDA MOTOR CO., LTD.

THIS VEHICLE HAS BEEN ADJUSTED TO  
IMPROVE EMISSION CONTROL PERFORMANCE  
WHEN OPERATED AT HIGH ALTITUDE

ALTITUDE PERFORMANCE ADJUSTMENT INSTRUCTIONS  
ARE AVAILABLE AT YOUR AUTHORIZED HONDA DEALER



NOTE: Do not attach the label to any part that can be easily removed from the vehicle.

**WARNING** Continuous operation at an altitude lower than 5,000 feet (1,500 m), with the carburetor adjusted for high altitudes, may cause the engine to idle roughly and stall and could cause engine damage from overheating.

When the vehicle is to be operated continuously below 5,000 feet (1,500 m); reinstall the # 55 main jet and adjust the idle speed to  $1,500 \pm 100$  rpm.

Be sure to do these adjustment at low altitude.

## 6. OIL PUMP

Refer to page 14-15 for oil pump disassembly/assembly.

To attach the oil pump, engage the slot in the rotor shaft with the tang on the sprocket shaft.

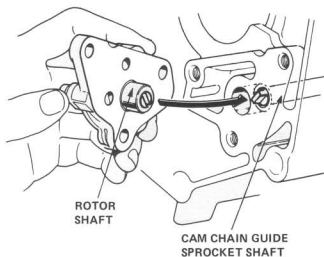

## 7. CYLINDER HEAD AND VALVES

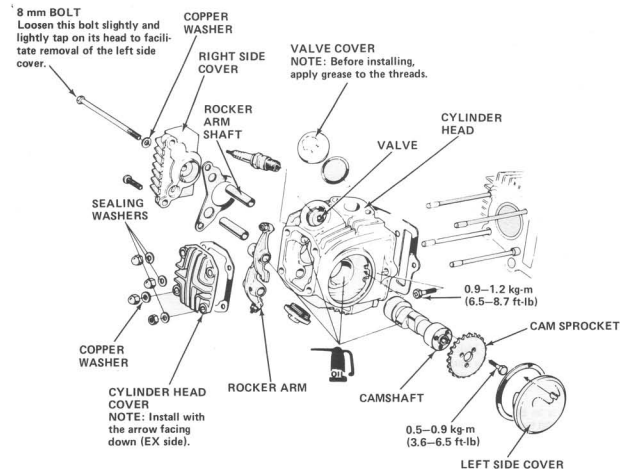

Remove the cylinder head (page 15-16).

Remove the valve spring cotters, retainers, springs and valves with a valve spring compressor.

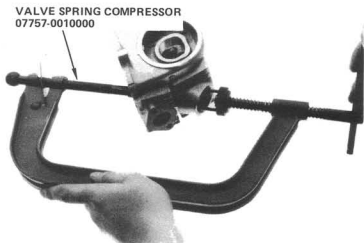

Valve disassembly as shown.

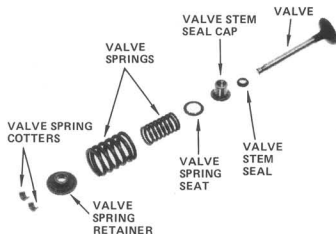

#### INSPECTION

##### CAMSHAFT O.D.

Measure the camshaft in two directions at right angles to each other (both sides).

	Standard	Service Limit
L-END	19.942–19.955 mm (0.78441–0.78563 in)	19.925 mm (0.78445 in)
R-END	29.942–29.955 mm (1.17882–1.17933 in)	29.915 mm (Replace) (1.17775 in)

##### CAMSHAFT END HOLE I.D.

Measure the end hole in two directions at right angles to each other (both ends).

	Standard	Service Limit
L-END	20.000–20.020 mm (0.7874–0.78819 in)	20.050 mm (Replace) (0.78937 in)
R-END	29.000–29.024 mm (1.14173–1.14267 in)	29.056 mm (Replace) (1.14393 in)

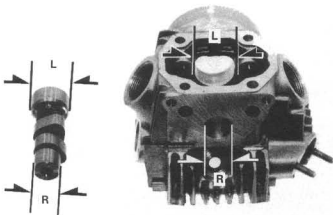

Tap the valve stems gently with a plastic hammer to firmly seat the cotters.

Refer to page 20 for cylinder head installation.

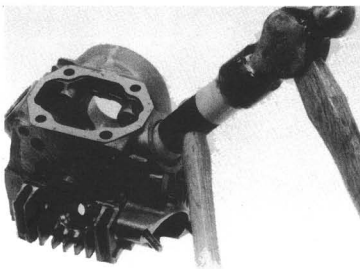

## 8. PISTON AND PISTON RINGS

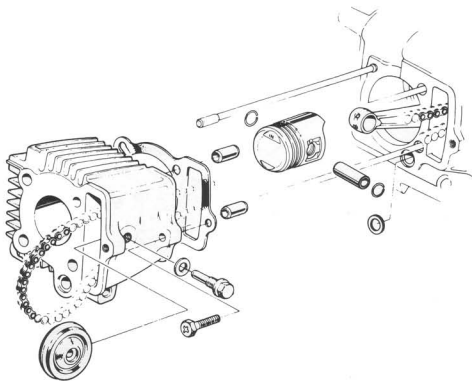

Remove the piston and piston ring (page 22).



Insert each piston ring into the cylinder and measure the ring end gap.

**SERVICE LIMIT:**  
TOP/SECOND  
0.5 mm (0.02 in)

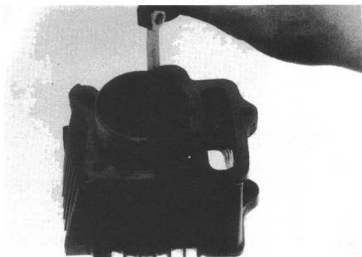

Install the piston rings with the marks facing up. Install the oil ring spacer first, then install the side rails.

**NOTE:** Avoid piston and piston ring damage during installation.

Space the piston ring end gaps 180 degrees apart as shown.

Do not align the oil ring (side rails) gaps.

After installation, the rings should rotate freely in the ring lands.

Refer to page 33 for piston and piston ring installation.

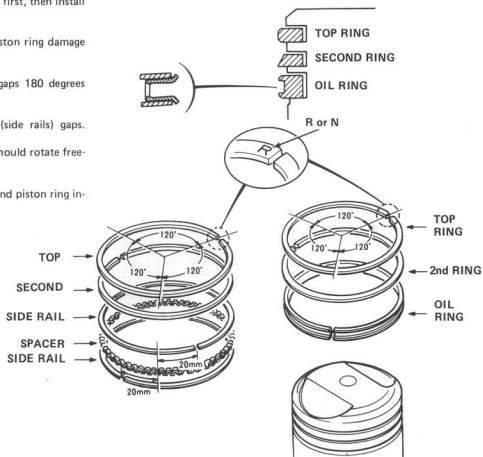

## 9. WIRING DIAGRAM

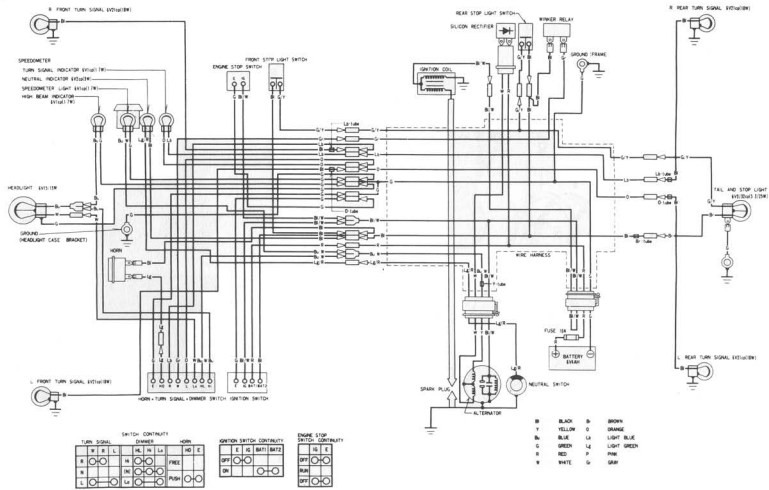

## IGNITION

STD. SPARK PLUG	NGK: C-7HS ND: U22FS
SPARK PLUG GAP	0.3-0.4 mm (0.012-0.016 in.)
IGNITION POINT GAP	
IGNITION TIMING	25° BTDC
DWELL ANGLE	
CONDENSER CAPACITY	0.27-0.35 MFD

## CARBURETION: CT-70

FLOAT LEVEL	20.0 mm
STD. MAIN JET	# 65 (carburetor model AT7B) # 58 (carburetor model 535A)
STD. SLOW JET	# 35
STD. NEEDLE POSITION	2nd notch from top
IDLE MIXTURE SCREW INITIAL SETTING	1 3/4 turns from closed position (model AT7B) 1 3/8 turns from closed position (model 535A)
IDLE SPEED	1500 RPM

## CARBURETION: CT-70H

FLOAT LEVEL	20.0 mm
STD. MAIN JET	# 60 (carburetor model MT7A) # 58 (carburetor model 594A)
STD. SLOW JET	# 35
STD. NEEDLE POSITION	2nd groove from top
IDLE MIXTURE SCREW INITIAL SETTING	1 3/4 turns from closed position (model MT7A) 1 3/8 turns from closed position (model 594A)
IDLE SPEED	1500 RPM

## ENGINE

ENGINE OIL CAPACITY	0.75qt. (24.0 oz.)	
OIL CIRCULATION CHECK POINT (Left and right sides are as viewed from the rider's position)	Lower left cylinder head nut	
TAPPET CLEARANCES	INTAKE: 0.05 mm (0.002 in.) EXHAUST: 0.05 mm (0.002 in.)	
VALVE TIMING	INTAKE: EXHAUST:	
COMPRESSION PRESSURE	10.8-15.2 KG/CM <sup>2</sup> (153-187 PSI) using kick starter	
PISTON TO CYL. CLEARANCE		
VALVE STEM TO GUIDE CLEARANCE	INTAKE: 0.01-0.05 mm (0.0004-0.0012 in.) EXHAUST: 0.05-0.05 mm (0.012-0.002 in.)	

## TIRES &amp; SUSPENSION

TIRE AIR PRESSURE	FRONT: 17 PSI REAR: 20 PSI	
FRONT FORK FLUID CAPACITY	To fill dry fork assembly 100-105 cc (3.4-3.6 oz.)	To refill after draining 80-85 cc (2.7-2.9 oz.)

CT-70/CT-70H

CT-70/CT-70H